

PROGRAMMABLE CONTROLLERS  
MELSEC-F

**FX CPU**

**FX(FX1N,FX1NC)→FX3 series Replacement Guidance**

Conversion tool

- GX Works2
- GX Developer Ver. 8



**FX**





# Safety Precautions

(Read these precautions before using.)

Before installation, operation, maintenance or inspection of this product, thoroughly read through and understand this manual and the associated manuals. Also, take care to handle the module properly and safely.

This manual classifies the safety precautions into two categories:  **WARNING** and  **CAUTION**.

 <b>WARNING</b>	Indicates that incorrect handling may cause hazardous conditions, resulting in death or severe injury.
 <b>CAUTION</b>	Indicates that incorrect handling may cause hazardous conditions, resulting in medium or slight personal injury or physical damage.

Depending on the circumstances, procedures indicated by  **CAUTION** may also cause severe injury.

It is important to follow all precautions for personal safety.

Store this manual in a safe place so that it can be taken out and read whenever necessary. Always forward it to the end user.

## 1. DESIGN PRECAUTIONS

### **WARNING**

- Make sure to include the following safety circuits outside the PLC to ensure safe system operation even during external power supply problems or PLC failure.  
Otherwise, malfunctions may cause serious accidents.
  - 1) Above all, the following components should be included: an emergency stop circuit, a protection circuit, an interlock circuit for opposite movements (such as normal vs. reverse rotation), and an interlock circuit (to prevent damage to the equipment at the upper and lower positioning limits).
  - 2) Note that when the PLC CPU detects an error, such as a watchdog timer error, during self-diagnosis, all outputs are turned off. Also, when an error that cannot be detected by the PLC CPU occurs in an input/output control block, output control may be disabled.  
External circuits and mechanisms should be designed to ensure safe machinery operation in such a case.
  - 3) Note that when an error occurs in a relay, triac or transistor output device, the output could be held either on or off.  
For output signals that may lead to serious accidents, external circuits and mechanisms should be designed to ensure safe machinery operation in such a case.

### **CAUTION**

- Do not bundle the control line together with or lay it close to the main circuit or power line. As a guideline, lay the control line at least 100mm (3.94") or more away from the main circuit or power line.  
Noise may cause malfunctions.
- Ground the shield wire or shield of the shielded cable at one point on the PLC. However, do not ground them at the same point as the high-voltage lines.  
Noise may cause malfunctions.
- Install module so that excessive force will not be applied to the terminal blocks.  
Failure to do so may result in wire damage/breakage or PLC failure.

# Safety Precautions

(Read these precautions before using.)

## 2. INSTALLATION PRECAUTIONS

### **WARNING**

- Make sure to shut down all phases of the power supply externally before installing.  
Failure to do so may cause electric shock or damage to the product.

### **CAUTION**

- Use the product within the generic environment specifications described in PLC main unit manual (Hardware Edition).  
Never use the product in areas with excessive dust, oily smoke, conductive dusts, corrosive gas (salt air, Cl<sub>2</sub>, H<sub>2</sub>S, SO<sub>2</sub>, or NO<sub>2</sub>), flammable gas, vibration or impacts, or expose it to high temperature, condensation, or rain and wind. If the product is used in such conditions, electric shock, fire, malfunctions, deterioration or damage may occur.
- Do not touch the conductive parts of the product directly.  
Doing so may cause device failures or malfunctions.
- Install the product securely using a DIN rail or mounting screws.
- Install the product on a flat surface.  
If the mounting surface is rough, undue force will be applied to the PC board, thereby causing nonconformities.
- When drilling screw holes or wiring, make sure that cutting and wiring debris do not enter the ventilation slits.  
Failure to do so may cause fire, equipment failures or malfunctions.
- Be sure to remove the dust proof sheet from the PLC's ventilation port when installation work is completed.  
Failure to do so may cause fire, equipment failures or malfunctions.
- Connect extension cables securely to their designated connectors.  
Loose connections may cause malfunctions.
- Turn off the power to the PLC before attaching or detaching the following devices.  
Failure to do so may cause device failures or malfunctions.
  - Peripheral devices, display modules, expansion boards and special adapters
  - I/O extension units/blocks, FX Series terminal block and the special function units/blocks
  - Battery and memory cassette

## 3. WIRING PRECAUTIONS

### **WARNING**

- Make sure to cut off all phases of the power supply externally before attempting wiring work.  
Failure to do so may cause electric shock.

# Safety Precautions

(Read these precautions before using.)

## CAUTION

- Connect the AC power supply to the dedicated terminals specified in this manual.  
If an AC power supply is connected to a DC input/output terminal or DC power supply terminal, the PLC will burn out.
- Do not wire vacant terminals externally.  
Doing so may damage the product.
- Use class D grounding (grounding resistance of 100Ω or less) with a wire of 2mm<sup>2</sup> or thicker on the grounding terminal of the PLC.  
However, do not connect the ground terminal at the same point as a heavy electrical system.
- When drilling screw holes or wiring, make sure cutting or wire debris does not enter the ventilation slits.  
Failure to do so may cause fire, equipment failures or malfunctions.
- Make sure to observe the following precautions in order to prevent malfunctions under the influence of noise.
  - Do not bundle the power line or twisted shielded cable together with or lay it close to the main circuit, high-voltage line, or load line.  
Otherwise, noise disturbance and/or surge induction are likely to take place. As a guideline, lay the control line at least 100mm (3.94") or more away from the main circuit, high-voltage line, or load line.
  - Ground the shield wire or shield of the shielded cable at one point on the PLC. However, do not use common grounding with heavy electrical systems.
- Make sure to properly wire to the terminal blocks in accordance with the following precautions.  
Failure to do so may cause electric shock, equipment failures, a short-circuit, wire breakage, malfunctions, or damage to the product.
  - The disposal size of the cable end should follow the dimensions described in the manual.
  - Tightening torque should follow the specifications in the manual.

## 4. STARTUP AND MAINTENANCE PRECAUTIONS

### WARNING

- Do not touch any terminal while the PLC's power is on.  
Doing so may cause electric shock or malfunctions.
- Before cleaning or retightening terminals, cut off all phases of the power supply externally.  
Failure to do so may cause electric shock.
- Before modifying or disrupting the program in operation or running the PLC, carefully read through this manual and the associated manuals and ensure the safety of the operation.  
An operation error may damage the machinery or cause accidents.

### CAUTION

- Do not disassemble or modify the PLC.  
Doing so may cause fire, equipment failures, or malfunctions.  
For repair, contact your local Mitsubishi Electric distributor.
- Turn off the power to the PLC before connecting or disconnecting any extension cable.  
Failure to do so may cause equipment failures or malfunctions.
- Turn off the power to the PLC before attaching or detaching the following devices.  
Failure to do so may cause equipment failures or malfunctions.
  - Peripheral devices, display modules, expansion boards and special adapters
  - I/O extension units/blocks, FX Series terminal block and the special function units/blocks
  - Battery and memory cassette

# Safety Precautions

(Read these precautions before using.)

## 5. DISPOSAL PRECAUTIONS

### CAUTION

- Please contact a certified electronic waste disposal company for the environmentally safe recycling and disposal of your device.

## 6. TRANSPORTATION PRECAUTIONS

### CAUTION

- The PLC is a precision instrument. During transportation, avoid impacts larger than those specified in the general specifications of the PLC main unit manual.  
Failure to do so may cause failures in the PLC.  
After transportation, verify the operations of the PLC.

# FX (FX1N, FX1NC) → FX3 series Replacement Guidance

Manual number	JY997D57901
Sub-number	A
Create date	October 2014

## Preface

This manual describes the replacement method of MELSEC-F series from FX (FX1N, FX1NC) series to FX3 series.

The replacement tools for sequence programs are described in the operation procedure of GX Works2/GX Developer Ver. 8 of the programming software. As for the handling method of the software, please refer to the Operating Manual of GX Works2/GX Developer Ver. 8.

As for the FX series related manuals, please refer to Appendix B.

This manual is not intended to guarantee the execution of industrial properties and other right, or permit execution rights. The company is not responsible for problems in the industrial properties and others arising from the use of the descriptions in this book.

## Outline Precautions

- This manual provides information for the use of the FX3 Series Programmable Controllers. The manual has been written to be used by trained and competent personnel. The definition of such a person or persons is as follows;
  - (1) Any engineer who is responsible for the planning, design and construction of automatic equipment using the product associated with this manual should be of a competent nature, trained and qualified to the local and national standards required to fulfill that role. These engineers should be fully aware of all aspects of safety with regards to automated equipment.
  - (2) Any commissioning or service engineer must be of a competent nature, trained and qualified to the local and national standards required to fulfill that job. These engineers should also be trained in the use and maintenance of the completed product. This includes being completely familiar with all associated documentation for the said product. All maintenance should be carried out in accordance with established safety practices.
  - (3) All operators of the completed equipment should be trained to use that product in a safe and coordinated manner in compliance to established safety practices. The operators should also be familiar with documentation which is connected with the actual operation of the completed equipment.

**Note:** The term ‘completed equipment’ refers to a third party constructed device which contains or uses the product associated with this manual

- This product has been manufactured as a general-purpose part for general industries, and has not been designed or manufactured to be incorporated in a device or system used in purposes related to human life.
- Before using the product for special purposes such as nuclear power, electric power, aerospace, medicine or passenger movement vehicles, consult with Mitsubishi Electric.
- This product has been manufactured under strict quality control. However when installing the product where major accidents or losses could occur if the product fails, install appropriate backup or failsafe functions in the system.
- When combining this product with other products, please confirm the standard and the code, or regulations with which the user should follow. Moreover, please confirm the compatibility of this product to the system, machine, and apparatus with which a user is using.
- If in doubt at any stage during the installation of the product, always consult a professional electrical engineer who is qualified and trained to the local and national standards. If in doubt about the operation or use, please consult the nearest Mitsubishi Electric distributor.
- Since the examples indicated by this manual, technical bulletin, catalog, etc. are used as a reference, please use it after confirming the function and safety of the equipment and system. Mitsubishi Electric will accept no responsibility for actual use of the product based on these illustrative examples.
- This manual content, specification etc. may be changed without a notice for improvement.
- The information in this manual has been carefully checked and is believed to be accurate; however, if you have noticed a doubtful point, a doubtful error, etc., please contact the nearest Mitsubishi Electric distributor.

## Trademarks

- Microsoft<sup>®</sup> and Windows<sup>®</sup> are trademarks of Microsoft Corporation of the United States registered in the United States and other nations.
- Ethernet is a trademark of Xerox Corporation (USA).
- MODBUS is a registered trademark of Schneider Electric SA.
- CiA and CANopen are registered Community Trademarks of CAN in Automation e.V.
- Other company names and product names are registered trademarks of the individual companies.



## Generic names and abbreviations used in this manual

Generic name, abbreviation	Description
<b>Programmable controller</b>	
FX programmable controller	Generic name of PLCs in FX3S, FX3G, FX3GE, FX3GC, FX3U, FX3UC, FX2N, FX2NC, FX1N, FX1NC, FX1S, FX2, FX2C, FX1, FX0N, FX0S, FX0 series
FX3 series	Generic name of PLCs in FX3S, FX3G, FX3GE, FX3GC, FX3U, FX3UC series
FX3G series	Generic name of PLCs in FX3G series
FX3GE series	Generic name of PLCs in FX3GE series
FX3GC series	Generic name of PLCs in FX3GC series
FX3U series	Generic name of PLCs in FX3U series
FX3UC series	Generic name of PLCs in FX3UC series
FX2N series	Generic name of PLCs in FX2N series
FX2NC series	Generic name of PLCs in FX2NC series
FX1N series	Generic name of PLCs in FX1N series
FX1NC series	Generic name of PLCs in FX1NC series
FX1S series	Generic name of PLCs in FX1S series
FX2 series	Generic name of PLCs in FX2 series
FX2C series	Generic name of PLCs in FX2C series
FX1 series	Generic name of PLCs in FX1 series
FX0N series	Generic name of PLCs in FX0N series
FX0S series	Generic name of PLCs in FX0S series
FX0 series	Generic name of PLCs in FX0 series
<b>Function expansion board</b>	
Communication function expansion board or communication board	Generic name of communication function expansion boards
232BD	FX3U-232-BD, FX3G-232-BD
422BD	FX3U-422-BD, FX3G-422-BD
485BD	FX3U-485-BD, FX3G-485-BD
USBBD	FX3U-USB-BD
Special adapter connection board or connector conversion board	Generic name of CNVBD
CNVBD	FX3U-CNV-BD, FX3G-CNV-ADP
<b>Special adapter</b>	
Communication special adapter or communication adapter	Generic name of communication special adapters
232ADP	FX3U-232ADP-MB
485ADP	FX3U-485ADP-MB
<b>Programming tool software</b>	
FX-PCS/WIN	Generic name of programming software FX-PCS/WIN
GX Developer	Generic name of programming software GX Developer
GX Works2	Generic name of programming software GX Works2
Handy programming panel	Generic name of FX-30P, FX-20P

# Table of Contents

---

Safety Precautions.....	(1)
Generic names and abbreviations used in this manual .....	3
<b>1. Introduction .....</b>	<b>6</b>
1.1 Outline .....	6
1.1.1 Replacement models .....	6
1.1.2 Necessity of renewal .....	6
1.2 Replacement of FX series .....	7
1.2.1 Replacement selection .....	7
1.2.2 program conversion .....	7
<b>2. Replacement of FX1N series .....</b>	<b>8</b>
2.1 Outline .....	8
2.1.1 Cautions .....	8
2.2 Replacement procedure .....	9
2.3 Selection of replacement models .....	10
2.3.1 Recommended replacement models .....	10
2.3.2 Cautions about hardware .....	14
2.4 Program conversion .....	18
2.4.1 Cautions for program change .....	18
2.4.2 Device comparison .....	21
2.5 Replacement of PLCs .....	23
<b>3. Replacement of FX1NC series .....</b>	<b>24</b>
3.1 Outline .....	24
3.1.1 Cautions .....	24
3.2 Replacement procedure .....	25
3.3 Selection of replacement models .....	26
3.3.1 Recommended replacement models .....	26
3.3.2 Cautions about hardware .....	28
3.4 Program conversion .....	30
3.4.1 Cautions for program change .....	30
3.4.2 Device comparison .....	33
3.5 Replacement of PLCs .....	34
<b>4. Program conversion method .....</b>	<b>35</b>
4.1 Preparation for program conversion .....	35
4.1.1 Program conversion procedure .....	35
4.1.2 Programming tool .....	36
4.2 Conversion of program by using GX Works2 .....	38
4.2.1 Preparation for program conversion .....	38
4.2.2 Reading of program .....	38
4.2.3 Model change to FX3 series (change of PLC type) .....	40
4.3 Correction of program and checking of operation .....	41
4.3.1 Checking and correction of program .....	41
4.3.2 Checking operation .....	41

## Table of Contents

---

Appendix A. Models affected by production termination .....	42
Appendix B. Related manuals.....	43
Appendix C. Frequently asked questions.....	50
Revision history .....	52

# 1. Introduction

---

## 1.1 Outline

Thank you very much for your continued use of Mitsubishi PLCs.

It may be time to renew your PLCs due to aging or deterioration over years of use, discontinued production of products, or termination of service or repair term.

This manual describes the procedure of replacing your FX (FX1N, FX1NC) series PLCs with FX3 series PLCs.

### 1.1.1 Replacement models

To replace FX (FX1N, FX1NC) series PLCs, a system configuration composed of FX3 series models is recommended.

Recommended replacement models introduced in this manual are general representative models selected based on the number of inputs and outputs, program capacity, and shapes of input and output terminals (terminal blocks, connectors, etc.). Depending on actual usage, models other than the recommended ones may be more suitable.

### 1.1.2 Necessity of renewal

- (1) Our products are composed of very reliable parts including a great number of electronic components.

When all components function normally, optimal functions and performance of the product will be realized.

However, some parts (electrolytic capacitors, relays, switches and others) have a limited service life.

The length of the service life varies depending on the part, and if used beyond the service life, optimal operation can not be expected and troubles or failures may occur. Generally, the deterioration of electronic components depends on the operating environment, and premature deterioration may occur if used in hot environments, overloaded conditions, or if incorrectly installed or connected.

Deterioration of parts due to aging or environment may shorten the service life of the product, and periodic renewal becomes necessary.

- (2) Systematic and planned preventive maintenance.

Failures are often caused by parts deteriorated due to aging or operating environment.

In equipment whose production is finished, it may take considerable time for recovery from failures.

It is necessary to secure spare parts and perform systematic and planned maintenance and renewal.

## Planning of renewal

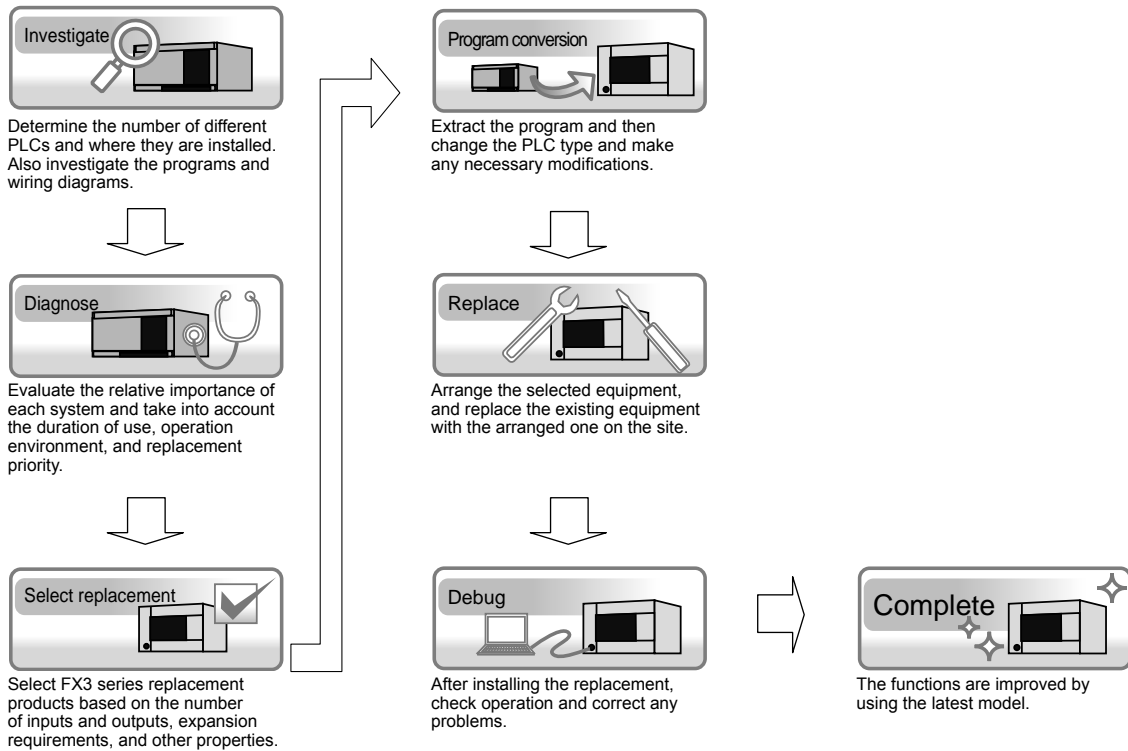

## 1.2 Replacement of FX series

### 1.2.1 Replacement selection

Select FX3 series main units and expansion equipment to replace existing systems.

FX1N series

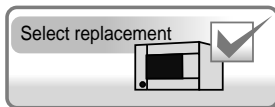

Refer to Chapter 2. "Replacement of FX1N series"

FX1NC series

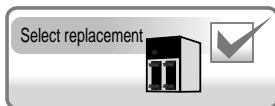

Refer to Chapter 3. "Replacement of FX1NC series"

### 1.2.2 Program conversion

Conversion of the FX1N, FX1NC series PLC programs to FX3 series can be done using GX Works2 or GX Developer Ver. 8.

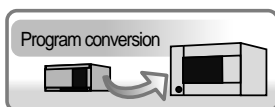

Refer to Chapter 4. "Program conversion method"

## 2. Replacement of FX1N series

---

### 2.1 Outline

This chapter describes the procedure to replace the FX1N series with its successor, the FX3G series. Replacement is recommended.

#### 2.1.1 Cautions

- (1) "Recommended replacement models" lists the most fitting FX3 series product based on specification comparison. Depending on the operation environment or the system configuration (connection of expansion equipment), or when the number of inputs and outputs in use is smaller, other products may be more appropriate than the recommended replacement model.
- (2) Recommended replacement models for extension blocks, extension units, special function modules, expansion boards, and batteries are selected based on compatibility with current FX3 series main units.
- (3) Pay close attention to notes marked as "Special remarks". For attributes such as external dimensions, there can be slight differences between the recommended replacement model and existing product. Before performing replacement, be sure to review other relevant details such as dimensions, and power supply requirements.
- (4) For instances where there is no recommended replacement model, a message stating "No recommended replacement model" will be shown. In this case, a FX3 series system may still be able to provide equivalent operation.  
Evaluate the requirements of the application and use a FX3 series system configuration for replacement.

## 2. Replacement of FX1N series

### 2.2 Replacement procedure

The replacement procedure is shown below.

FX3G series products are generally recommended as replacements for FX1N series products.

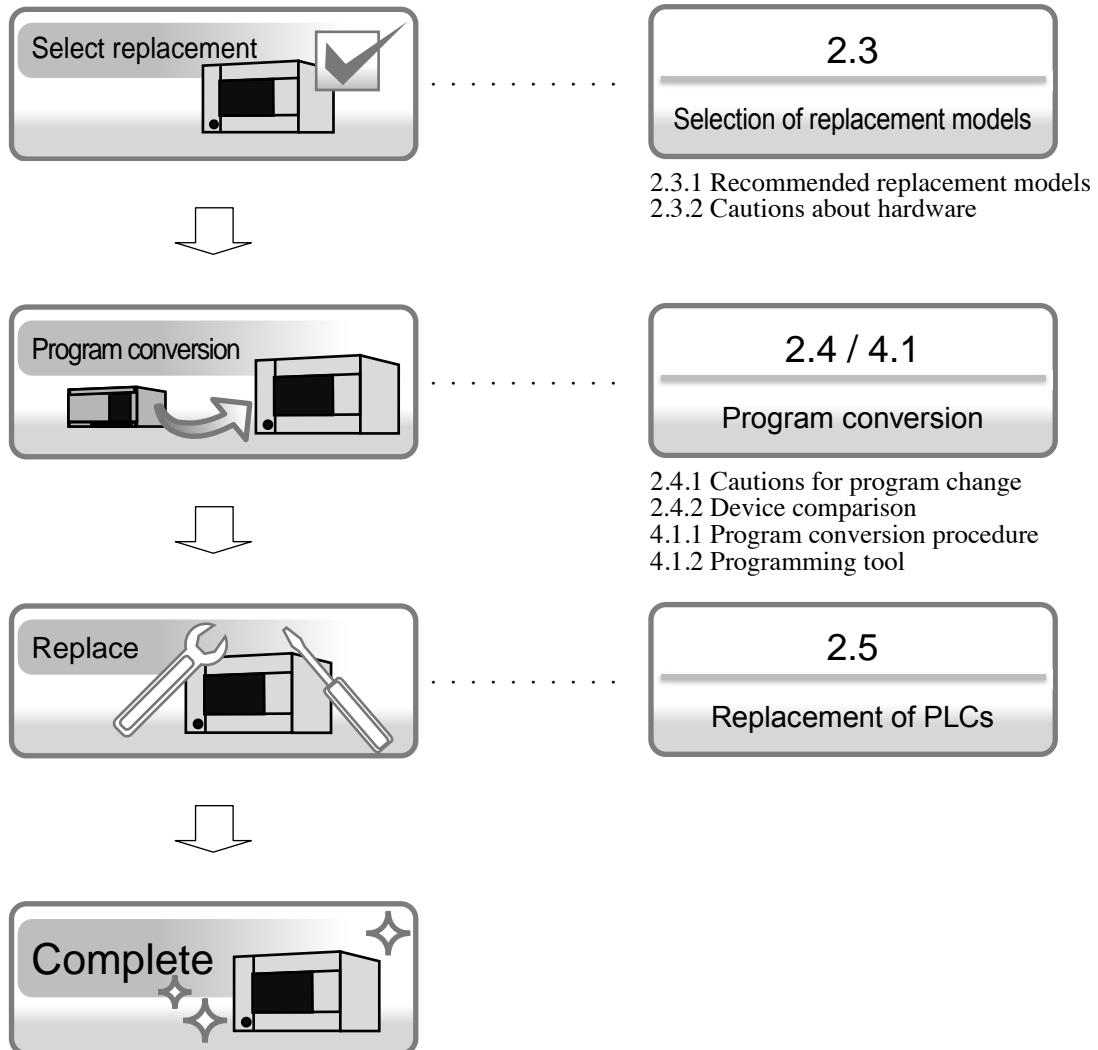

## 2. Replacement of FX1N series

### 2.3 Selection of replacement models

#### 2.3.1 Recommended replacement models

(1) Main unit recommended replacement models

FX3G series recommended replacement models corresponding to the FX1N series are introduced. Please replace currently used main units with the following recommended models.

■ FX1N series and recommended replacement models (main units)

FX1N series		Recommended replacement model	Special remarks
Description	Model name	Model name	
Main unit (100 to 240V AC power supply) (sink/source input, relay output)	FX1N-14MR-ES/UL	FX3G-14MR/ES(-A)	*1
	FX1N-24MR-ES/UL	FX3G-24MR/ES(-A)	
	FX1N-40MR-ES/UL	FX3G-40MR/ES(-A)	
	FX1N-60MR-ES/UL	FX3G-60MR/ES(-A)	
Main unit (100 to 240V AC power supply) (sink/source input, transistor source output)	FX1N-14MT-ESS/UL	FX3G-14MT/ESS	
	FX1N-24MT-ESS/UL	FX3G-24MT/ESS	
	FX1N-40MT-ESS/UL	FX3G-40MT/ESS	
	FX1N-60MT-ESS/UL	FX3G-60MT/ESS	
Main unit (12 to 24V DC power supply) (sink/source input, relay output)	FX1N-14MR-DS	FX3G-14MR/DS	*1 The supply voltage range of the FX3G series is 20.4 to 28.8V DC. 12V DC is not available. *2
	FX1N-24MR-DS	FX3G-24MR/DS	
	FX1N-40MR-DS	FX3G-40MR/DS	
	FX1N-60MR-DS	FX3G-60MR/DS	
Main unit (12 to 24V DC power supply) (sink/source input, transistor source output)	FX1N-14MT-DSS	FX3G-14MT/DSS	
	FX1N-24MT-DSS	FX3G-24MT/DSS	
	FX1N-40MT-DSS	FX3G-40MT/DSS	
	FX1N-60MT-DSS	FX3G-60MT/DSS	

\*1: The depth is changed from 75 mm (FX1N series) to 86 mm (FX3G series).

\*2: The FX1N series used with 12V DC cannot be replaced.



## 2. Replacement of FX1N series

### (2) Expansion equipment recommended replacement models

When changing from FX1N to FX3G series main units, the following expansion equipment and option equipment must be replaced at the same time.

If replacement models with the same performance are not available, please review and consider to re-design the system following the comments included in the "Special remarks" column.

■ Expansion and option equipment required to be replaced when FX1N series main units are changed to FX3G series.

Models connectable to FX1N series		Recommended replacement models connectable to FX3G	Special remarks
Description	Model name	Model name	
Special adapter (for RS-232C communication)	FX2NC-232ADP	FX3U-232ADP-MB	The FX3G-CNV-ADP is needed for connection of the recommended replacement model (FX3G series).
Special adapter (for RS-485 communication)	FX2NC-485ADP	FX3U-485ADP-MB	The FX3G-CNV-ADP is needed for connection of the recommended replacement model (FX3G series).
Expansion board (for special adapter connection)	FX1N-CNV-BD	FX3G-CNV-ADP	
Expansion board (input board)	FX1N-4EX-BD	FX3G-4EX-BD	
Expansion board (output board)	FX1N-2EYT-BD	FX3G-2EYT-BD	
Expansion board (analog input)	FX1N-2AD-BD	FX3G-2AD-BD	
Expansion board (analog output)	FX1N-1DA-BD	FX3G-1DA-BD	
Expansion board (analog volume)	FX1N-8AV-BD	FX3G-8AV-BD	
Expansion board (RS-232C communication)	FX1N-232-BD	FX3G-232-BD	
Expansion board (RS-422 communication)	FX1N-422-BD	FX3G-422-BD	
Expansion board (RS-485 communication)	FX1N-485-BD	FX3G-485-BD(-RJ)	
Memory cassette	FX1N-EEPROM-8L	FX3G-EEPROM-32L	
Display module	FX1N-5DM	FX3G-5DM	
Special function block (analog input and output)	FX0N-3A	FX3U-3A-ADP	The FX3G-CNV-ADP is needed for connection of the FX3G series main unit.
Special function block (ASI master)	FX2N-32ASI-M	No replacement model	The FX2N-32ASI-M cannot be connected to the FX3G series. Create a new system using the CC-Link and others.
Special function unit (I/O link master)	FX2N-16LNK-M	No replacement model	The FX2N-16LNK-M cannot be connected to the FX3G series. Create a new system using the CC-Link and others.

FX0N series expansion units, expansion blocks and special function blocks connectable to the FX1N series cannot be connected to the FX3G series.

Update the current equipment to proper expansion equipment compatible with the FX3G series.

## 2. Replacement of FX1N series

### (3) FX1N expansion equipment usable when the main unit is changed to FX3G series

When main units are changed from FX1N series to FX3G series, the following FX1N expansion equipment in general can be used.

However, if use is expected to continue for a long period, it is recommended to replace units following the practices of preventative maintenance.

#### ■ Expansion equipment usable when main units are changed from FX1N series to FX3G series

Input/output extension unit	Input/output extension block	Output extension block	Analog input and output mix
FX2N-32ER-ES/UL	FX2N-8ER-ES/UL	FX2N-8EYR-ES/UL	FX2N-5A
FX2N-32ET-ESS/UL	FX2N-8ER	FX2N-8EYT-ESS/UL	Temperature sensor, temperature control
FX2N-48ER-ES/UL	Input extension block	FX2N-8EYR-S-ES/UL	
FX2N-48ET-ESS/UL	FX2N-8EX-ES/UL	FX2N-16EYR-ES/UL	FX2N-4AD-TC
FX2N-48ER-DS	FX2N-16EX-ES/UL	FX2N-16EYT-ESS/UL	FX2N-4AD-PT
FX2N-48ET-DSS	FX2N-8EX-UA1/UL	FX2N-8EYR	FX2N-2LC
FX2N-48ER-UA1/UL	FX2N-8EX	FX2N-8EYT	Communication/network
FX2N-32ER	FX2N-16EX	FX2N-8EYT-H	
FX2N-32ES	FX2N-16EX-C	FX2N-16EYR	FX2N-32CCL
FX2N-32ET	FX2N-16EXL-C	FX2N-16EYT	FX2N-16CCL-M
FX2N-48ER		FX2N-16EYT-C	FX2N-64CL-M
FX2N-48ET		FX2N-16EYS	Connector conversion, extension cable
FX2N-48ER-D		Analog input	
FX2N-48ET-D		FX2N-2AD	FX2N-CNV-BC
		FX2N-4AD	FX0N-30EC/FX0N-65EC
		FX2N-8AD	
		Analog output	
		FX2N-2DA	
		FX2N-4DA	

### (4) Expansion equipment newly available with the FX3G series

When main units are changed from FX1N series to FX3G series, the following FX3G series expansion equipment can be used.

Since FX3 series special adapters do not consume any input or output points, they can be added without affecting the number of I/O points.

System performance can be increased over that of the existing system by using equipment available for the FX3G series.

#### ■ Expansion equipment for the FX3G series

Analog input	Analog volume	Loader function memory	Communication/network
FX3U-4AD-ADP	FX3G-8AV-BD	FX3G-EEPROM-32L	FX3G-232-BD
FX3G-2AD-BD	Temperature sensor, temperature control	Power source extension unit	FX3G-422-BD
FX3U-4AD			FX3G-485-BD(-RJ)
Analog output	FX3U-4AD-PT-ADP	FX3U-1PSU-5V	FX3U-232ADP-MB
FX3U-4DA-ADP	FX3U-4AD-PTW-ADP	Input/output expansion board	FX3U-485ADP-MB
FX3G-1DA-BD	FX3U-4AD-PNK-ADP		FX3U-64CCL
FX3U-4DA	FX3U-4AD-TC-ADP	FX3G-4EX-BD	FX3U-16CCL-M
Analog input and output mix	FX3U-4LC	FX3G-2EYT-BD	FX3U-ENET-ADP
	Display module		FX3U-ENET
FX3U-3A-ADP	FX3G-5DM		FX3U-32DP
			FX3U-CAN
			FX3U-J1939

The FX3G-CNV-ADP is needed for connection of a special adapter.

## 2. Replacement of FX1N series

---

(5) Battery

The batteries used in the FX1N series and FX3G series main units are different.

Select batteries based on the main unit.

Battery for FX1N series	FX1N-BAT
Battery for FX3G series	FX3U-32BL

(6) Use of the MELSEC-F series Selection Tool

By using the MELSEC-F series Selection Tool, it is possible to confirm whether or not a system configuration containing FX1N series expansion equipment is valid for a FX3G series main unit.

## 2. Replacement of FX1N series

### 2.3.2 Cautions about hardware

- Comparison of FX1N series and FX3G series and cautions for replacement

This is a list of hardware cautions. When performing replacement, please refer to the manual of each model and confirm details list here.

- Hardware differences of FX1N series and FX3G series, and cautions

No.	Item	Difference		Caution
		FX1N series	FX3G series	
1	Depth	75 mm	86 mm	The depth is different between the FX1N series and the FX3G series.
2	Optional battery and mounting position	FX1N-BAT	FX3U-32BL	Type name (model) is different.
3	Input hardware filter (when digital filter is zero) - High-speed counter - Input interrupt function - Pulse catch function	X0, X1 : 10 $\mu$ s X2 to X7 : 50 $\mu$ s	X0, X1, X3, X4 : 10 $\mu$ s X2, X5, X6, X7 : 50 $\mu$ s	Noise, not detected in FX1N, may affect input of FX3G. If necessary, implement a noise countermeasure external to the main unit.
4	FX0N series expansion unit and block	Usable	Not usable	Update the current equipment to proper expansion equipment compatible with the FX3G series.
5	Terminal resistance of 485-BD, 485ADP	Packaged together with the BD or ADP, and to be selected and mounted.	Built into the BD or ADP, selectable using a switch.	In the communication equipment for the FX3G series, the resistance value can be selected using a built-in switch.
6	Wire size of 485-BD, 485ADP	AWG26 to 16	AWG22 to 20	Wire size is different. A large wire size may not be usable in FX3G.
7	Rated voltage in power specification of DC power type	12 to 24V DC	24V DC	The rated voltage is different between the FX1N series and the FX3G series.
8	Configuration when the special communication adapter is connected	[Configuration when the special communication adapter is connected] FX1N-CNV-BD+ FX2NC-***ADP	[Configuration when the special communication adapter is connected] FX3G-CNV-ADP+ FX3U-***ADP	The configuration at the time of connection is different because the shape and mounting position of the special adapter connecting equipment and the special communication adapter are different.
9	Availability of FX0N-3A	Usable	Not usable (FX3U-3A-ADP is usable).	The FX3G-CNV-ADP is needed to connect an adapter to the main unit of the FX3G series. Program modifications are also needed.
10	Availability of FX-USB-AW	Usable	Not necessary (USB Mini-B port is built in).	When connecting the FX3G series to the personal computer via the USB, connect it to the built-in USB port with a communication cable such as GT09-C30USB-5P.

## 2. Replacement of FX1N series

Fig. 1. Outline drawing.

The FX1N series and FX3G series main units have slightly different dimensions.

Take into account any differences when performing replacement.

Differences • Depth is different by 11mm.

### ■ FX1N series main unit

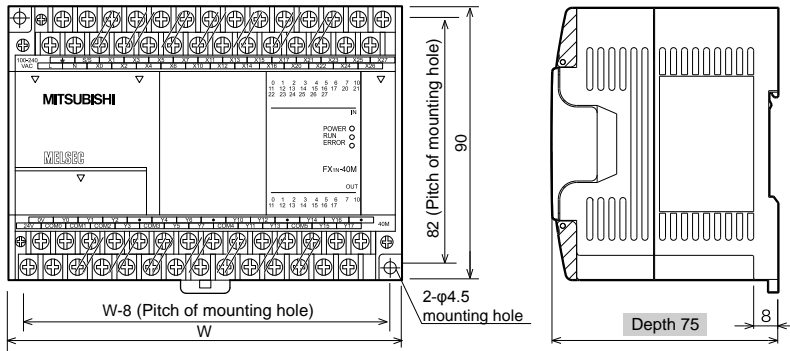

Outer coat color: Munsell 0.08GY/7.64/0.81  
Unit: mm

Type name	W (mm)	Mass (kg)
FX1N-14M	90	0.45
FX1N-24M	90	0.45
FX1N-40M	130	0.65
FX1N-60M	175	0.8

- Terminal stand is connected by M3 terminal screw.
- 35mm wide DIN rail can be mounted.

### ■ FX3G series main unit

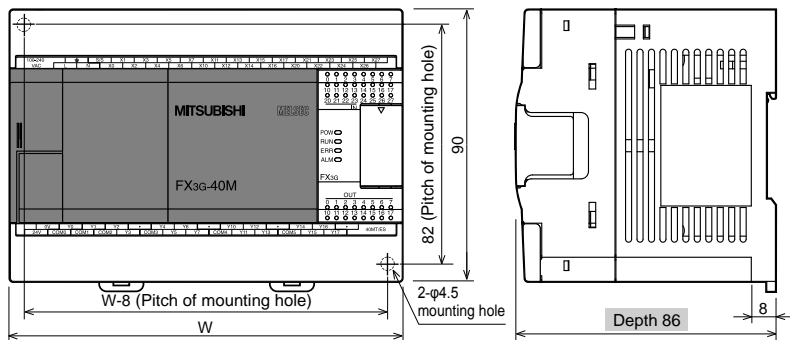

Outer coat color: Munsell 0.08GY/7.64/0.81  
Unit: mm  
Top cover: Munsell N1.5

Type name	W (mm)	Mass (kg)
FX3G-14M	90	0.50
FX3G-24M	90	0.55
FX3G-40M	130	0.70
FX3G-60M	175	0.85

- Terminal stand is connected by M3 terminal screw.
- 35mm wide DIN rail can be mounted.

Fig. 2. Wiring diagram of S/S terminal in FX3G series.

• Input wiring example of AC power supply type

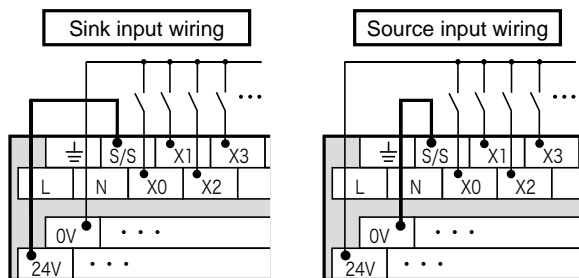

• Input wiring example of DC power supply type

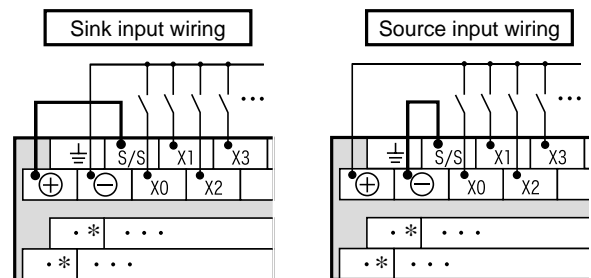

\*: Do not connect with [•] terminals.

## 2. Replacement of FX1N series

---

Table 1. Cable size of European type terminal connectors

For connection with RS-485 communication equipment, use a twisted pair cable with shielding.  
Conforming wire size and tightening torque are as follows.

	Wire size of one-wire connection	Wire size of two-wire connection	Wire ferrule with insulation sleeve (wire size)	Tightening torque	Insulation sheath stripping length*
FX1N-485-BD	AWG26 to AWG16		Not usable	0.6N·m	6mm
FX2NC-485ADP	AWG26 to AWG16	AWG26 to AWG20	Not usable	0.4 to 0.5N·m	8mm
FX3G-485-BD FX3U-485ADP-MB	AWG22 to AWG20	AWG22	Usable (AWG22 to AWG20)	0.22 to 0.25N·m	9mm

\*: Insulation sheath stripping length shows the dimension when connecting the wire to the terminal directly.

For details, please refer to the FX Series User's Manual (Data Communication Edition) JY997D16901.

## 2. Replacement of FX1N series

### 2.4 Program conversion

#### 2.4.1 Cautions for program change

- Operational difference of FX1N series and FX3G series  
The FX3G series can use the same instructions used in the FX1N series, but the following operations are different. Depending on the hardware configuration or program contents, check the corresponding items by correcting or replacing the sequence program or checking operations.

#### ■ Operational difference and cautions about program and system

Item	Operational difference		Caution		
	FX1N series	FX3G series			
<b>Communication</b>					
1	AS-i system	Compatible	Incompatible	The FX2N-32ASI-M and the FX2N-16LNK-M cannot be connected to the FX3G series. Construct a new system.	
2	MELSEC-I/O LINK				
3	Baud rate in parallel link	19,200bps	115,200bps	Since the communication speed becomes higher, communication may be affected by noise.	
4	Link time in parallel link	Ordinary parallel link mode	70ms + master station operation period (ms) + slave station operation period (ms)	15ms + master station operation period (ms) + slave station operation period (ms)	Since the link time becomes shorter, check again the update timing of link devices.
5		High-speed parallel link mode	20ms + master station operation period (ms) + slave station operation period (ms)		
6	Terminal resistance of 485-BD and 485ADP	Supplied as accessories	Built in the communication unit	In the FX3G series, the terminal resistance is built in the communication unit. Select the resistance value using a selection switch.	
<b>Positioning</b>					
7	Positioning instruction Current value for output Y000	D8140, D8141	D8340, D8341	Change allocation to the corresponding device.	
8	Positioning instruction Current value for output Y001	D8142, D8143	D8350, D8351		
9	Positioning instruction Bias speed	D8145	D8342(Y000) D8352(Y001)		
10	Positioning instruction Maximum speed	D8146, D8147	D8343, D8344(Y000) D8353, D8354(Y001)		
11	Positioning instruction Acceleration/deceleration time	D8148	Acceleration time D8348(Y000), D8358(Y001) Deceleration time D8349(Y000), D8359(Y001)		

## 2. Replacement of FX1N series

Item		Operational difference		Caution
		FX1N series	FX3G series	
12	Positioning instruction Clear signal for pulse Y000	Y002	Y004 Y004 can be changed to another Y device specified by D8464 while M8464 (Clear signal device designation function enable flag) is ON.	Change allocation to the corresponding device.
13	Positioning instruction Clear signal for pulse Y001	Y003	Y005 Y005 can be changed to another Y device specified by D8465 while M8465 (Clear signal device designation function enable flag) is ON.	
<b>Basic and applied instructions</b>				
14	Pointer designation in CJ and CALL instructions	If the destination of a jump or call is not available, an operation error occurs when the CJ or CALL instruction is executed.	If the destination of a jump or call is not available, a syntax error occurs. However, if the pointer is indexed, an operation error occurs when the CJ or CALL instruction is executed in the same way as the FX1N series.	In the FX3G series, error detection before RUN is implemented. Check the program, and correct it to avoid errors.
15	Occupied points for S3 of the PID instruction	S3 occupies 25 points.	S3 occupies 29 points.	The number of occupied points is increased. Confirm devices are allocated correctly.
16	Combined operation of the ZRST and PLS instructions	The ZRST instruction resets only the state of the designated device. When the ZRST instruction and PLS instruction designate the same device and the ZRST instruction has been programmed previously, the PLS instruction is not performed again unless the drive contact is changed from OFF to ON.	The ZRST instruction resets not only the state of the designated device, but also resets the previous status for the PLS or PLF instructions. When the ZRST instruction and PLS instruction designate the same device and the ZRST instruction has been programmed previously, the PLS instruction is performed again and sets to ON the designated device after the ZRST instruction is executed if the drive contact for the PLS instruction remains ON.	Change the drive contact for the PLS instruction to the LDP instruction, or add the MEP instruction between the drive contact and the PLS instruction. Refer to 7.12 Cautions on the PLS and PLF instructions in the FX3G/FX3U/FX3GC/FX3UC Series Programming Manual for the details.
17	Clear coil by ZRST instruction	If the ZRST instruction designating a timer or counter as the operand is executed, the coil of these timers or counters are not cleared.	If the ZRST instruction designating a timer or counter as the operand is executed, the coil of these timers or counters are also cleared.	In the FX1N series, to clear the coil of a timer or counter, an RST instruction was needed, but in the FX3G series, batch resetting is possible using the ZRST instruction.
18	Combined operation of the ZRST instruction and a counter*. * : Excluding high-speed counter	The ZRST instruction resets the designated counter value, but does not reset the coil (in the previous status) for the counter. Even if the ZRST instruction which designates a same device as the counter OUT instruction is programmed, the counter does not start counting unless the contact is changed from OFF to ON.	The ZRST instruction resets not only the designated counter value, but also resets the coil (in the previous status) for the counter. When the ZRST instruction which designates a same device as the counter OUT instruction is executed, the counter value becomes 1 in the next scan if the drive contact remains ON.	Change the drive contact for the counter OUT instruction to the LDP instruction, or add the MEP instruction between the drive contact and the counter OUT instruction.



## 2. Replacement of FX1N series

Item		Operational difference		Caution
		FX1N series	FX3G series	
19	PRUN instruction	If M devices are designated in S· and D·, and the number of devices necessary for operation exceeds the range of M devices, it is not an error, but the arithmetic operation is conducted within the possible range.	If M devices are designated in S· and D·, and the number of devices necessary for operation exceeds the range of M devices, an operation error (6706) occurs, and the arithmetic operation is not conducted.	In the FX3G series, the error detection in instruction execution is implemented. Please check the program, and change the device allocation so as to avoid errors.
<b>Special devices</b>				
20	Special auxiliary relay M8004 Error detection	M8004 turns ON when either of M8060, M8061, M8063, M8064, M8065, M8066 or M8067 is ON.	M8004 turns ON when either of M8060, M8061, M8064, M8065, M8066 or M8067 is ON.	When M8004 is used to check errors in M8063, add the check for M8063.
21	Clear timing of M8024 (BMOV direction designation)	When power is turned OFF	When changed from RUN to STOP	Note that the clear timing is changed.
22	Clear the devices M8031 (Non-latched memory all clear) and M8032 (Latched memory all clear).	Special device D is not initialized.	Special device D is also initialized.	Note that cleared devices are changed.
23	Clear timing of M8049 (Annunciator enable)	When power is turned OFF	When changed from RUN to STOP	Note that the clear timing is changed.
24	Clear timing of M8050 to M8059 (Interrupt disable)	When power is turned OFF	When changed from RUN to STOP	Note that the clear timing is changed.
25	Clear timing of M8063 and D8063 (Serial communication error)	When changed from STOP to RUN	When power is turned OFF	Not cleared when changed from STOP to RUN; when necessary to clear, add an initializing program using the RST command.
26	Devices for analog function expansion board	M8112 to M8114 D8112 to D8114 (FX1N-1DA-BD) (FX1N-2AD-BD)	M8260 to M8279 D8260 to D8279 (FX3G-1DA-BD) (FX3G-2AD-BD)	Note that available devices are changed.
27	Devices for analog special expansion	Any devices in the program (FXON-3A)	M8280 to M8299 D8280 to D8299 (FX3U-3A-ADP)	Note that available devices are changed.
28	Clear timing of M8161 (8-bit processing mode)	When power is turned OFF	When changed from RUN to STOP	Note that the clear timing is changed.
29	Clear timing of special auxiliary relays D8122 and D8123	When changed from STOP to RUN	When changed from RUN to STOP	Note that the clear timing is changed.
30	Special data register D8158	D8158 is provided for the display module.	D8158 latches the inverter communication error occurrence step (ch 2). * D8300 is provided as a device for the display module.	Since the device function is changed, take proper action.
31	Special data register D8159	D8159 designates the M device for the display module, or functions as the flag to detect voltage drop in the battery FX1N-BAT.	Not usable * D8301 is provided as the M device for the display module. Voltage drop in the battery can be directly detected in M8005 and M8006.	Since the device function is changed, take proper action.
32	Special auxiliary relay M8046	If S0 to S999 are ON and M8047 is enabled.	If S0 to S899 and S1000 to S4095 are ON when M8047 is enabled.	Since the object device range differs, add a program for initializing S1000 to S4095 using the RST or ZRST instruction.

## 2. Replacement of FX1N series

---

Item		Operational difference		Caution
		FX1N series	FX3G series	
33	Special data register D8040 to D8047	D8040 to D8047 store up to 8 state numbers in the ON state among S0 to S999.	D8040 to D8047 store up to 8 state numbers in the ON state among S0 to S899 and S1000 to S4095.	Since the object device range differs, add a program for initializing S1000 to S4095 using the RST or ZRST instruction.

## 2. Replacement of FX1N series

### 2.4.2 Device comparison

- Comparison of FX1N series and FX3G series devices

The devices used in FX1N series can be used in the FX3G series including special devices.

The following table also shows devices implemented in the FX3G series.

■ Device comparison table (the shaded cells indicates difference in specification).

Device		FX1N series		FX3G series		
Division	Use	Number	No. of points	Number	No. of points	
M	Auxiliary relay	General use	M0 to M383	384points	M0 to M383	384 points
		EEPROM keep	M384 to M511	128 points	M384 to M1535	1,152 points
		Capacitor keep	M512 to M1535	1,024 points	—	—
		General use	—	—	M1536 to M7679 (They can be set to “latched” when the optional battery is mounted).	6,144 points
		Special use	M8000 to M8255	256 points	M8000 to M8511	512 points
S	State relay	For initial state use (EEPROM keep)	S0 to S9	10 points	S0 to S9	10 points
		EEPROM keep	S10 to S127	118 points	S10 to S999	990 points
		Capacitor keep	S128 to S999	872 points	—	—
		General use	—	—	S1000 to S4095 (They can be set to “latched” when the optional battery is mounted).	3,096 points
		100ms	T0 to T199	200 points	T0 to T199 (T192 to T199 for routine)	200 points 8 points
T	Timer (on-delay)	10ms	T200 to T245	46 points	T200 to T245	46 points
		1ms	—	—	T256 to T319	64 points
		1ms retentive type	T246 to T249 (Capacitor keep)	4 points	T246 to T249 (EEPROM keep)	4 points
		100ms retentive type	T250 to T255 (Capacitor keep)	6 points	T250 to T255 (EEPROM keep)	6 points
		A	Analog volume	VR1: D8030, VR2: D8031	2 points	VR1: D8030, VR2: D8031
C	Counter	General up counter (16-bit)	C0 to C15	16 points	C0 to C15	16 points
		General up counter (16-bit) EEPROM keep	C16 to C31	16 points	C16 to C199	184 points
		General up counter (16-bit) Capacitor keep	C32 to C199	168 points	—	—
		General bi-directional counter (32-bit) up/down	C200 to C219	20 points	C200 to C219	20 points
		General bi-directional counter (32-bit) up/down (Capacitor keep)	C220 to C234 (Capacitor keep)	15 points	C220 to C234 (EEPROM keep)	15 points
	High speed counter (EEPROM keep)	1-phase 1-count input bi-directional (32-bit) [variable]	C235 to C255 60kHz 2 points +10kHz 4 points	6 points	C235 to C255 60kHz 4 points +10kHz 2 points	6 points
		1-phase 2-count input bi-directional (32-bit) [variable]	C246 to C250 60kHz 1 points or 10kHz 2 points	2 points	C246 to C250 60kHz 2 points or 10kHz 2 points	2 points
		2-phase 2-count input bi-directional (32-bit) [variable]	C251 to C255 30kHz 1 points or 5kHz 2 points	2 points	C251 to C255 30kHz 2 points + 5kHz 1 points	3 points

## 2. Replacement of FX1N series

Device		FX1N series		FX3G series		
Division	Use	Number	No. of points	Number	No. of points	
D	General use (16-bit)	D0 to D127	128 points	D0 to D127	128 points	
	EEPROM keep (16-bit)	D128 to D255	128 points	D128 to D1099	972 points	
	Capacitor keep (16-bit)	D256 to D7999	7,744 points	—	—	
	General use (16-bit)	—	—	D1100 to D7999 (They can be set to “latched” when the optional battery is mounted).	6,900 points	
	File register EEPROM keep	D1000 to D7999 (They can be set as file registers beginning with D1000 in increments of 500 points by a parameter in the program area (EEPROM)).	MAX.7,000 points	D1000 to D7999 (They can be set as file registers beginning with D1000 in increments of 500 points by a parameter in the program area (EEPROM)).	MAX. 7,000 points	
	Special use (16-bit)	D8000 to D8255	256 points	D8000 to D8511	512 points	
	Index (16-bit)	V0 to V7, Z0 to Z7	16 points	V0 to V7, Z0 to Z7	16 points	
	Extension register (16-bit)	—	—	R0 to R23999 (They can be set to “latched” when the optional battery is mounted).	24,000 points	
P	Extension file register (16-bit)	—	—	ER0 to ER23999 They are stored in the EEPROM built in the main unit or in an attached memory cassette.	24,000 points	
	Pointer	For JUMP, CALL branch	P0 to P127	128 points	P0 to P2047	2,048 points
		For input interrupt	I0 □□ to I5 □□	6 points	I0 □□ to I5 □□	6 points
		For timer interrupt	—	—	I6 □□ to I8 □□	3 points

## 2. Replacement of FX1N series

### 2.5 Replacement of PLCs

The following includes main points of caution when replacing main units and expansion equipment. For more details on each item, please refer to the reference page of this manual, and the hardware and programming manuals of the PLCs and related documents.

Applicable equipment	Item	Measures and cautions	Reference page
Main unit	Input and output wiring change	Wiring change required for terminal block connections.	Section 2.3
Special adapter	Expansion to the main unit	The FX3G-CNV-ADP is needed to connect a special adapter to the FX3G series main unit.	
RS-485 communication expansion equipment	Checking cable size for wiring of FX1N-485-BD or FX2NC-485ADP	Make sure FX3G RS-485 series communication equipment conforms to the corresponding wire size. If it does not conform, change the wire size.	
	Handling of terminal resistance of FX1N-485-BD or FX2NC-485ADP	FX3G RS-485 series communication equipment incorporates terminal resistance. Select the resistance value by using the built-in selection switch.	
Other expansion equipment	Wiring to each unit and block	Re-wiring is needed for terminal block type equipment.	Section 2.4
Operation confirmation	Operation and test of sequence program	Operate the replacement sequence program and hardware equipment, check and adjust the equipment function and operation timing. Note the difference in function mentioned in the reference page, and make sure the equipment operates in conformity with the designed specification.	

### 3. Replacement of FX1NC series

---

#### 3.1 Outline

This chapter describes the procedure to replace the FX1NC series with its successor, the FX3GC series. Replacement is recommended.

##### 3.1.1 Cautions

- (1) “Recommended replacement models” lists the most fitting FX3 series product based on specification comparison. Depending on operation environment or the system configuration (connection status of expansion equipment), or when the number of inputs and outputs in use is smaller, other products may be more appropriate than the recommended replacement model.
- (2) Recommended replacement models for extension blocks and others are selected based on the compatibility with the FX3 series main units.
- (3) Pay close attention to notes marked as “Special remarks.” For attributes such as external dimensions, there can be slight differences between the recommended replacement model and existing product. Before performing replacement, be sure to review other relevant details such as dimensions, and power supply requirements.
- (4) For instances where there is no recommended replacement model, a message stating “No recommended replacement model” will be shown. In this case, a FX3 series system may still be able to provide equivalent operation. Evaluate the requirements of the application and use a FX3 series system configuration for replacement.

## 3.2 Replacement procedure

The replacement procedure is shown below.

FX3GC series products are generally recommended as replacements for FX1NC series products.

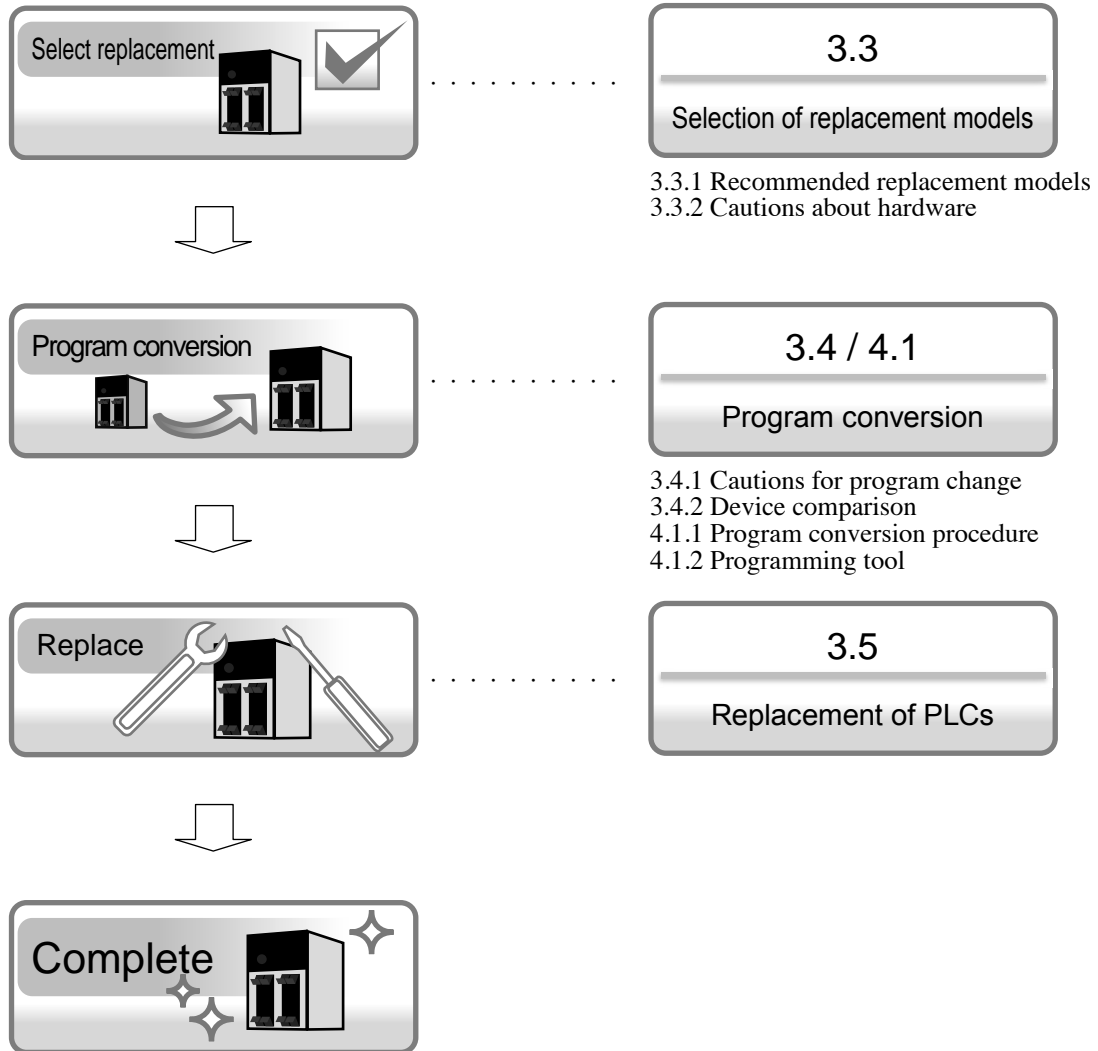

## 3.Replacement of FX1NC series

### 3.3 Selection of replacement models

#### 3.3.1 Recommended replacement models

(1) Main unit recommended replacement models

FX3GC recommended replacement models corresponding to the FX1NC series are introduced. Please replace currently used main units with the following recommended models.

■ FX1NC series and recommended replacement models (main units)

FX1NC series		Recommended replacement model	Special remarks
Description	Model name	Model name	
Main unit (24V DC power supply) (sink input, transistor sink output)	FX1NC-16MT	FX3GC-32MT/D	
	FX1NC-32MT	FX3GC-32MT/D	

(2) Expansion equipment recommended replacement models

When changing from FX1NC to FX3GC main units, the following expansion equipment and option equipment must be replaced at the same time.

If replacement models with the same performance are not available, please review and consider to re-design the system following the comments included in the “Special remarks” column.

■ List of expansion equipment and option equipment required to be replaced when FX1NC series main units are changed to FX3GC series.

Models connectable to FX1NC series		Recommended replacement models connectable to FX3GC	Special remarks
Description	Model name	Model name	
Special function block (for Analog input and output mix)	FX0N-3A	FX3U-3A-ADP	
Special adapter (for RS-232C communication)	FX2NC-232ADP	FX3U-232ADP-MB	
Special adapter (for RS-485 communication)	FX2NC-485ADP	FX3U-485ADP-MB	
Special function block (ASI master)	FX2N-32ASI-M	No replacement model	The FX2N-32ASI-M cannot be connected to the FX3GC series. Create a new system using the CC-Link and others.
Special function unit (I/O link master)	FX2N-16LNK-M	No replacement model	The FX2N-16LNK-M cannot be connected to the FX3GC series. Create a new system using the CC-Link and others.



### 3.Replacement of FX1NC series

- (3) FX1NC expansion equipment usable when the main unit is changed to FX3GC series  
 When main units are changed from FX1NC series to FX3GC series, the following FX1NC expansion equipment in general can be used.  
 However, if use is expected to continue for a long period, it is recommended to replace units following the practices of preventative maintenance.

■ Expansion equipment usable when main units are changed from FX1NC series to FX3GC series

Input/output extension unit	Output extension block	Analog input	Communication/network
FX2NC-64ET FX2N-8ER	FX2NC-16EYT-DSS FX2NC-16EYR-T-DS	FX2N-2AD	FX2N-32CCL
		FX2N-4AD	FX2N-16CCL-M
Input extension block	FX2NC-32EYT-DSS FX2N-8EYR-ES/UL	FX2N-8AD	FX2N-64CL-M
		Analog output	Connector conversion, extension cable
FX2NC-16EX-DS FX2NC-16EX-T-DS	FX2N-8EYT-ESS/UL FX2N-8EYT-H	FX2N-2DA	FX2NC-CNV-IF FX2N-CNV-BC FX0N-30EC / FX0N-65EC
		FX2N-4DA	
FX2NC-32EX-DS	FX2N-8EYR-S-ES/UL	Analog input and output mix	
FX2N-8EX-ES/UL	FX2N-16EYR-ES/UL	FX2N-5A	
FX2N-8EX-UA1/UL	FX2N-16EYT-ESS/UL	Temperature sensor, temperature control	
FX2N-16EX-ES/UL	FX2N-16EYT-C	FX2N-4AD-TC	
FX2N-16EX-C	FX2N-16EYS	FX2N-4AD-PT	
FX2N-16EXL-C		FX2N-2LC	

For connection of FX2N series expansion blocks, a FX2NC-CNV-IF or FX3UC-1PS-5V is needed.

- (4) Expansion equipment newly available with the FX3GC series  
 When main units are changed from FX1NC series to FX3GC series, the following FX3 series expansion equipment can be used.  
 Since FX3 series special adapters do not consume any inputs or output points, they can be added without affecting the number of I/O points.  
 System performance can be increased over that of the existing system by using equipment available for the FX3GC series.

■ Expansion equipment for the FX3GC series

Analog input	Temperature sensor, temperature control	Communication/network
FX3UC-4AD	FX3U-4AD-PT-ADP FX3U-4AD-PTW-ADP FX3U-4AD-PNK-ADP	FX3U-232ADP-MB
FX3U-4AD-ADP		FX3U-485ADP-MB
FX3U-4AD		FX3U-16CCL-M
Analog output	FX3U-4AD-TC-ADP FX3U-4LC	FX3U-64CCL
FX3U-4DA-ADP		FX3U-ENET-ADP
FX3U-4DA		FX3U-ENET
Analog input and output	Power supply extension unit	FX3U-32DP
FX3U-3A-ADP	FX3UC-1PS-5V	FX3U-CAN
		FX3U-J1939

For connection of FX3U series expansion blocks, a FX2NC-CNV-IF or FX3UC-1PS-5V is needed.

- (5) Battery  
 In the FX3GC series, the battery FX3U-32BL for the FX3U series is available as an option.
- (6) Use of the MELSEC-F series selection tool  
 By using the MELSEC-F series Selection Tool, it is possible to confirm whether or not a system configuration containing FX1NC series expansion equipment is valid for a FX3GC series main unit.

## 3.Replacement of FX1NC series

### 3.3.2 Cautions about hardware

- Comparison of FX1NC series and FX3GC series and cautions for replacement

This is a list of hardware cautions. When performing replacement, please refer to the manual of each model and confirm details there.

- Hardware differences of FX1NC series and FX3GC series, and cautions

No.	Item	Difference		Caution
		FX1NC series	FX3GC series	
1	Width	35 mm	34 mm	The width is different between the FX1NC series and the FX3GC series.
2	Input hardware filter (when digital filter is zero) - High-speed counter - Input interrupt function - Pulse catch function	X0, X1: 10 $\mu$ s X2 to X7: 50 $\mu$ s	X0, X1, X3, X4: 10 $\mu$ s X2, X5, X6, X7: 50 $\mu$ s	Noise, not detected in FX1NC, may affect input of FX3GC. If necessary, implement a noise countermeasure external to the main unit.
3	FX0N series expansion block	Usable	Not usable	Update the current equipment to proper expansion equipment compatible with the FX3GC series.
4	Terminal resistance of 485ADP	Packaged together with the ADP, and to be selected and mounted.	Built into the ADP, selectable using a switch.	In the communication equipment for the FX3GC series, the resistance value can be selected using a built-in switch.
5	Wire size of 485ADP	AWG26 to 16	AWG22 to 20	Wire size is different. A large wire size may not be usable in FX3GC.
6	Width when the special communication adapter is connected	[Configuration when the special communication adapter is connected] FX2NC-***ADP	[Configuration when the special communication adapter is connected] FX3U-***ADP	The width is different because the shape and mounting position of the special adapter connecting equipment and the special communication adapter are different.
7	Availability of FX0N-3A	Usable	Not usable (FX3U-3A-ADP is usable).	Program modification is required.
8	Availability of FX-USB-AW	Usable	Not necessary (USB Mini-B port is built in).	When connecting the FX3GC series to the personal computer via the USB, connect it to the built-in USB port with a communication cable such as GT09-C30USB-5P.
9	Maximum resistance load	0.1 A/1 point	0.1 A/1 point (Y0 and Y1 are 0.3 A/1 point).	The maximum resistance load of Y0 and Y1 is different.

### 3.Replacement of FX1NC series

Table 1. Cable size European terminal type connectors

For connection with RS-485 communication equipment, use a twisted pair cable with shielding. Conforming wire size and tightening torque are as follows.

	Wire size of one-wire connection	Wire size of two-wire connection	Wire ferrule with insulation sleeve (wire size)	Tightening torque	Insulation sheath stripping length*
FX2NC-485ADP	AWG26 to AWG16	AWG26 to AWG20	Not usable	0.4 to 0.5N·m	8mm
FX3U-485ADP-MB	AWG22 to AWG20	AWG22	Usable (AWG22 to AWG20)	0.22 to 0.25N·m	9mm

\*: Insulation sheath stripping length shows the dimension when connecting the wire to the terminal directly.

For details, please refer to the FX Series User's Manual (Data communication edition)JY997D13301.

Fig. 1. Outline drawing.

The overall dimensions of the FX1NC is almost identical, but the FX3GC has a 1mm shorter width, depending on model.

#### ■ FX1NC series main unit

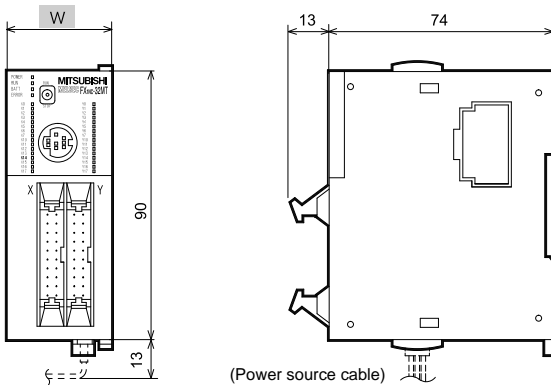

Outer coat color: Munsell 0.08GY/7.64/0.81  
Unit: mm

Type name	W (mm)	Mass(kg)
FX1NC-16MT	35	0.20
FX1NC-32MT	35	0.20

Only 35 mm wide DIN rail can be mounted.

[Accessory]

- FX2NC-100MPCB type power cable (1m)
- FX2NC-100BPCB type power cable (1m)

#### ■ FX3GC series main unit

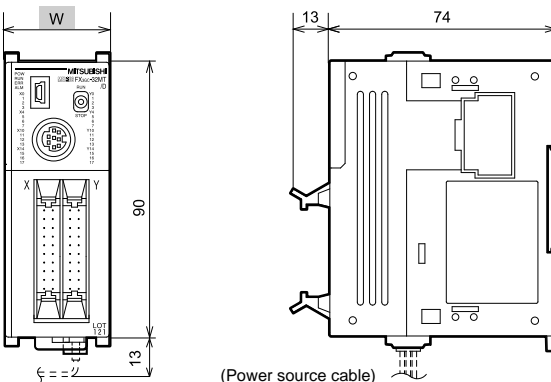

Outer coat color: Munsell 0.08GY/7.64/0.81  
Unit: mm

Type name	W (mm)	Mass (kg)
FX3GC-32MT/D, DSS	34	0.20

Only 35 mm wide DIN rail can be mounted.

[Accessory]

- FX3GC-32MT/D
- FX2NC-100MPCB type power cable(1m)
- FX2NC-100BPCB type power cable(1m)
- FX3GC-32MT/DSS
- FX2NC-100MPCB type power cable(1m)

## 3.Replacement of FX1NC series

### 3.4 Program conversion

#### 3.4.1 Cautions for program change

- Operational difference of FX1NC series and FX3GC series

The FX3GC series can use the same instructions used in the FX1NC series, but the following operations are different. Depending on the hardware configuration or program contents, check the corresponding items by correcting or replacing the sequence program or checking operations.

■ Function difference and cautions about program and system

Item		Operational difference		Caution
		FX1NC series	FX3GC series	
<b>Communication</b>				
1	AS-i system	Compatible	Incompatible	The FX2N-32ASI-M and the FX2N-16LNK-M cannot be connected to the FX3GC series. Construct a new system.
2	MELSEC-I/O LINK			
3	Baud rate in parallel link	19,200 bps	115,200bps	Since the communication speed becomes higher, communication may be affected by noise.
4	Link time in parallel link	Ordinary parallel link mode	70ms + master station operation period (ms) + slave station operation period (ms)	Since the link time becomes shorter, check again the update timing of link devices.
5		High-speed parallel link mode	20ms + master station operation period (ms) + slave station operation period (ms)	
6	Terminal resistance of 485-BD and 485ADP	Supplied as accessories	Built in the communication unit	In the FX3GC series, the terminal resistance is built in the communication unit. Select the resistance value using a selection switch.
<b>Positioning</b>				
7	Positioning instruction Current value for output Y000	D8140, D8141	D8340, D8341	Change allocation to the corresponding device.
8	Positioning instruction Current value for output Y001	D8142, D8143	D8350, D8351	
9	Positioning instruction Bias speed	D8145	D8342(Y000) D8352(Y001)	
10	Positioning instruction Maximum speed	D8146, D8147	D8343, D8344(Y000) D8353, D8354(Y001)	
11	Positioning instruction Acceleration/deceleration time	D8148	Acceleration time D8348(Y000), D8358(Y001) Deceleration time D8349(Y000), D8359(Y001)	
12	Positioning instruction Clear signal for pulse Y000	Y002	Y004	
			Y004 can be changed to another Y device specified by D8464 while M8464 (Clear signal device designation function enable flag) is ON.	

### 3.Replacement of FX1NC series

Item		Operational difference		Caution
		FX1NC series	FX3GC series	
13	Positioning instruction Clear signal for pulse Y001	Y003	Y005 Y004 can be changed to another Y device specified by D8465 while M8465 (Clear signal device designation function enable flag) is ON.	Change allocation to the corresponding device.
<b>Basic and applied instructions</b>				
14	Pointer designation in CJ and CALL instructions	If the destination of a jump or call is not available, an operation error occurs when the CJ or CALL instruction is executed.	If the destination of a jump or call is not available, when not in RUN state, a syntax error occurs. However, if the pointer is indexed, an operation error occurs when the CJ or CALL instruction is executed in the same way as the FX1N series.	In the FX3GC series, error detection before RUN is implemented. Check the program, and correct it to avoid errors.
15	Occupied points for S3 of the PID instruction	S3 occupies 25 points.	S3 occupies 29 points.	The number of occupied points is increased. Confirm devices are allocated correctly.
16	Combined operation of the ZRST and PLS instructions	The ZRST instruction resets only the state of the designated device. When the ZRST instruction and PLS instruction designate the same device and the ZRST instruction has been programmed previously, the PLS instruction is not performed again unless the drive contact is changed from OFF to ON.	The ZRST instruction resets not only the state of the designated device, but also resets the previous status for the PLS or PLF instructions. When the ZRST instruction and PLS instruction designate the same device and the ZRST instruction has been programmed previously, the PLS instruction is performed again and sets to ON the designated device after the ZRST instruction is executed if the drive contact for the PLS instruction remains ON.	Change the drive contact for the PLS instruction to the LDP instruction, or add the MEP instruction between the drive contact and the PLS instruction. Refer to “7.12 Cautions on the PLS and PLF instructions” in the FX3G/FX3U/FX3GC/FX3UC Programming Manual for the details.
17	Clear of coil by ZRST instruction	If the ZRST instruction designating a timer or counter as the operand is executed, the coil of these timers or counters are not cleared.	If the ZRST instruction designating a timer or counter as the operand is executed, the coil of this timer or counter is also cleared.	In the FX1N series, to clear the coil of a timer or counter, an RST instruction was needed, but in the FX3GC series, batch resetting is possible using the ZRST instruction.
18	Combined operation of the ZRST instruction and a counter*. * : Excluding high-speed counter	The ZRST instruction resets the designated counter value, but does not reset the coil (in the previous status) for the counter. Even if the ZRST instruction which designates a same device as the counter OUT instruction is programmed, the counter does not start counting unless the contact is changed from OFF to ON.	The ZRST instruction resets not only the designated counter value, but also resets the coil (in the previous status) for the counter. When the ZRST instruction which designates a same device as the counter OUT instruction is executed, the counter value becomes 1 in the next scan if the drive contact remains ON.	Change the drive contact for the counter OUT instruction to the LDP instruction, or add the MEP instruction between the drive contact and the counter OUT instruction.
19	PRUN instruction	If M devices are designated in S· and D·, and the number of devices necessary for operation exceeds the range of M devices, it is not an error, but the arithmetic operation is conducted within the possible range.	If M devices are designated in S· and D·, and the number of devices necessary for operation exceeds the range of M devices, an operation error (6706) occurs, and the arithmetic operation is not conducted.	In the FX3GC series, the error detection in instruction execution is implemented. Please check the program, and change the device allocation so as to avoid errors.

### 3.Replacement of FX1NC series

Item	Operational difference		Caution	
	FX1NC series	FX3GC series		
<b>Special devices</b>				
20	Special auxiliary relay M8004 Error detection	M8004 turns ON when either of M8060, M8061, M8063, M8064, M8065, M8066 or M8067 is ON.	M8004 turns ON when either of M8060, M8061, M8064, M8065, M8066 or M8067 is ON.	When M8004 is used to check errors in M8063, add the check for M8063.
21	Clear timing of M8024 (BMOV direction designation)	When power is turned OFF.	When changed from RUN to STOP	Note that the clear timing is changed.
22	Clear the devices M8031 (Non-latched memory all clear) and M8032 (Latched memory all clear).	Special device D is not initialized.	Special device D is also initialized.	Note that cleared devices are changed.
23	Clear timing of M8049 (Annunciator enable)	When power is turned OFF.	When changed from RUN to STOP	Note that the clear timing is changed.
24	Clear timing of M8050 to M8059 (Interrupt disable)	When power is turned OFF.	When changed from RUN to STOP	Note that the clear timing is changed.
25	Clear timing of M8063 and D8063 (Serial communication error)	When changed from STOP to RUN	When power is turned OFF.	Not cleared when changed from STOP to RUN; when necessary to clear, add an initializing program using the RST command.
26	Devices for analog special expansion	Any devices in the program (FX0N-3A)	M8280 to M8299 D8280 to D8299 (FX3U-3A-ADP)	Note that available devices are changed.
27	Clear timing of M8161 (8-bit processing mode)	When power is turned OFF.	When changed from RUN to STOP	Note that the clear timing is changed.
28	Clear timing of special auxiliary relays D8122 and D8123	When changed from STOP to RUN	When changed from RUN to STOP	Note that the clear timing is changed.
29	Special auxiliary relays M8046	If S0 to S999 are ON and M8047 is enabled.	If S0 to S899 and S1000 to S4095 are ON when M8047 is enabled.	Since the object device range differs, add a program for initializing S1000 to S4095 using the RST or ZRST instruction.
30	Special data register D8040 to D8047	D8040 to D8047 store up to 8 state numbers in the ON state among S0 to S999.	D8040 to D8047 store up to 8 state numbers in the ON state among S0 to S899 and S1000 to S4095.	Since the object device range differs, add a program for initializing S1000 to S4095 using the RST or ZRST instruction.

## 3.Replacement of FX1NC series

### 3.4.2 Device comparison

- Comparison of FX1NC series and FX3GC series devices

The devices used in FX1NC series can be used in the FX3GC series including special devices.

The following table also shows devices implemented in the FX3GC series.

■ Device comparison table (The shaded cells indicates difference in specification).

Device		FX1NC series		FX3GC series		
Division	Use	Number	No. of points	Number	No. of points	
M	Auxiliary relay	General use	M0 to M383	384 points	M0 to M383	384 points
		EEPROM keep	M384 to M511	128 points	M384 to M1535	1,152 points
		Capacitor keep	M512 to M1535	1,024 points	—	—
		General use	—	—	M1536 to M7679 (They can be set to “latched” when the optional battery is mounted).	6,144 points
		Special use	M8000 to M8255	256 points	M8000 to M8511	512 points
S	State relay	For initial state use (EEPROM keep)	S0 to S9	10 points	S0 to S9	10 points
		EEPROM keep	S10 to S127	118 points	S10 to S999	990 points
		Capacitor keep	S128 to S999	872 points	—	—
		General use	—	—	S1000 to S4095 (They can be set to “latched” when the optional battery is mounted).	3,096 points
T	Timer (on-delay)	100ms	T0 to T199	200 points	T0 to T199 (T192 to T199 for routine)	200 points 8 points
		10ms	T200 to T245	46 points	T200 to T245	46 points
		1ms	—	—	T256 to T319	64 points
		1ms retentive type	T246 to T249 (Capacitor keep)	4 points	T246 to T249 (EEPROM keep)	4 points
		100ms retentive type	T250 to T255 (Capacitor keep)	6 points	T250 to T255 (EEPROM keep)	6 points
C	Counter	General up counter (16-bit)	C0 to C15	16 points	C0 to C15	16 points
		General up counter (16-bit) EEPROM keep	C16 to C31	16 points	C16 to C199	184 points
		General up counter (16-bit) Capacitor keep	C32 to C199	168 points	—	—
		General bi-directional counter (32-bit) up/down	C200 to C219	20 points	C200 to C219	20 points
		General bi-directional counter (32-bit) up/down (Capacitor keep)	C220 to C234	15 points	C220 to C234 (EEPROM keep)	15 points
	Highspeed counter (EEPROM keep)	1-phase 1-count input bi-directional (32-bit) [variable]	C235 to C255 60kHz 2 points +10kHz 4 points	6 points	C235 to C255 60kHz 4 points +10kHz 2 points	6 points
		1-phase 2-count input bi-directional (32-bit) [variable]	C246 to C250 60kHz 1 points or 10kHz 2 points	2 points	C246 to C250 60kHz 2 points or 10kHz 2 points	2 points
		2-phase 2-count input bi-directional (32-bit) [variable]	C251 to C255 30kHz 1 points or 5kHz 2 points	2 points	C251 to C255 30kHz 2 points + 5kHz 1 points	3 points

### 3.Replacement of FX1NC series

D	Data register (32-bit used in a pair)	General use (16-bit)	D0 to D127	128 points	D0 to D127	128 points
		EEPROM keep (16-bit)	D128 to D255	128 points	D128 to D1099	972 points
		Capacitor keep (16-bit)	D256 to D7999	7,744 points	—	—
		General use (16-bit)	—	—	D1100 to D7999 (They can be set to “latched” when the optional battery is mounted).	6,900 points
		File register EEPROM keep	D1000 to D7999 (They can be set as file registers beginning with D1000 in increments of 500 points by a parameter in the program area (EEPROM)).	MAX. 7,000 points	D1000 to D7999 (They can be set as file registers beginning with D1000 in increments of 500 points by a parameter in the program area (EEPROM))	MAX.7,000 points
		Special use (16-bit)	D8000 to D8255	256 points	D8000 to D8511	512 points
		Index (16-bit)	V0 to V7 Z0 to Z7	16 points	V0 to V7 Z0 to Z7	16 points
		Extension register (16-bit)	—	—	R0 to R23999 (They can be set to “latched” when the optional battery is mounted)	24,000 points
P	Pointer	For JUMP, CALL branch	P0 to P127	128 points	P0 to P2047	2,048 points
		For input interrupt	I0 □□ to I5 □□	6 points	I0 □□ to I5 □□	6 points
		For timer interrupt	—	—	I6 □□ to I8 □□	3 points

### 3.5 Replacement of PLCs

The following includes main points of caution when replacing main units and expansion equipment. As for the detail of each item, please refer to the reference page of this manual, and the hardware and programming manuals of the PLCs and related documents.

Applicable equipment	Item	Measures and cautions	Reference page
Main unit	Input and output connection	FX1NC input and output connectors, as well as 24V DC connectors are identical to those of the FX3GC, in shape and signal arrangement. Detach the connectors from the FX1NC and attach them to the FX3GC.	
	24V DC power connection		
RS-485 communication expansion equipment	Checking cable size for wiring of FX2NC-485ADP	Make sure FX3GC RS-485 communication equipment conforms to the corresponding wire size. If it does not conform, change the wire size.	Section 3.3
	Handling of terminal resistance of FX2NC-485ADP		
Other expansion equipment	Wiring to each unit and block	Re-wiring is needed for terminal block type equipment.	
Operation confirmation	Operation and test of sequence program	Operate the replacement sequence program and hardware equipment, check and adjust the equipment function and operation timing. Note the difference in function mentioned in the reference page, and make sure the equipment operates in conformity with the designed specification.	Section 3.4



# 4. Program conversion method

## 4.1 Preparation for program conversion

To convert the program to FX3 series, use an appropriate programming tool, such as a personal computer software application.

The convert procedure and necessary tools are explained in the following sections.

### 4.1.1 Program conversion procedure

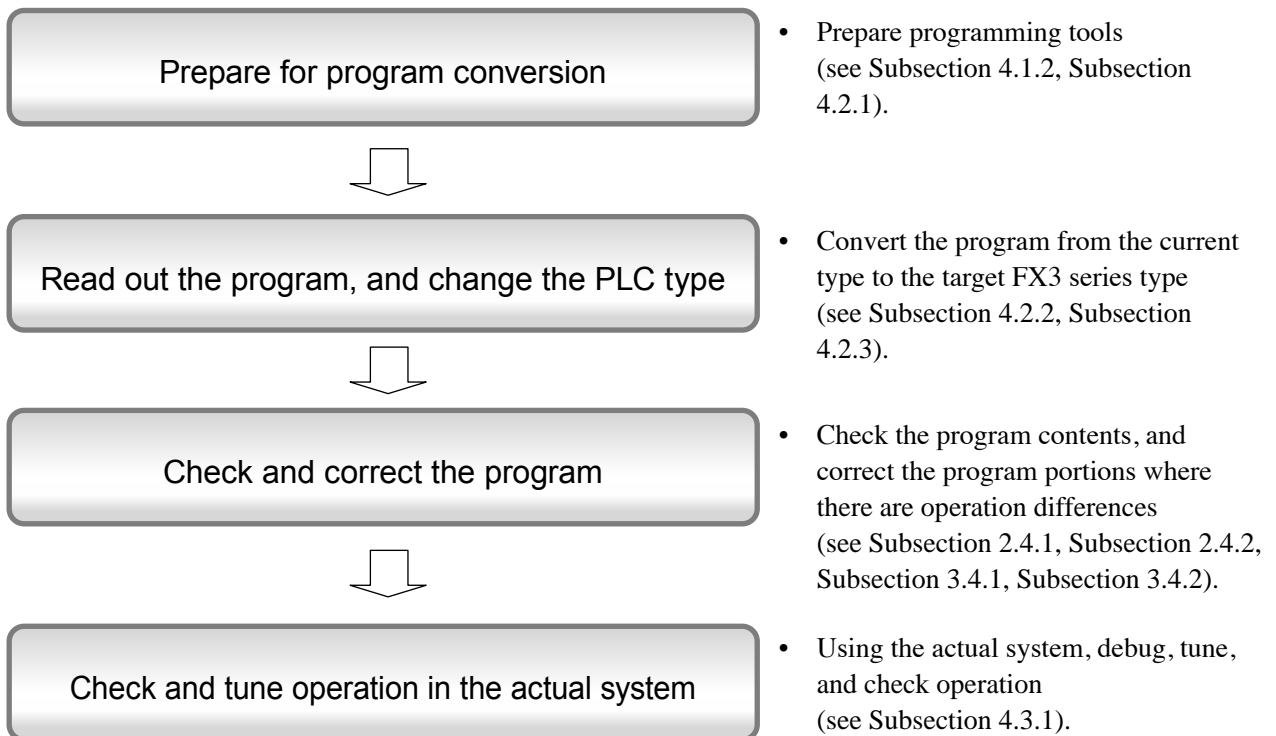

## 4. Program conversion method

### 4.1.2 Programming tool

- Programming tool

Program conversion tools are available in two forms: personal computer software and handy programming panel (HPP).

Tools with ◎ marks in the table below are recommended for program conversion to the FX3 series.

Tools with △ marks indicate that FX3 series functions cannot be added and that it may not be possible to convert the program based on the connected device.

Model	Software			HPP	
	GX Works2*1	GX Developer Ver. 8*2	FX-PCS/ WIN-E	FX-30P	FX-20P
FX1N, FX1NC series	◎	○	○	◎	○
FX3G, FX3GC series	◎	○	△	◎	△

△: Can only be programmed within the same functional range as the FX1N series.

- Programming tools supporting the FX3 series

Type	Product names supporting the FX3 series
Programming software	GX Developer Ver. 8*2 Japanese (SW8D5C-GPPW-J) English (SW8D5C-GPPW-E)
	GX Works2 Japanese (SW1DNC-GXW2-J) English (SW1DNC-GXW2-E)
Handy programming panel	FX-30P Japanese, English and Chinese (Simplified Chinese and Traditional Chinese)

\*1: FX3GC series requires Ver. 1.77F or later of GX Works2.

\*2: In the FX3G series, GX Developer Ver. 8.72A or later is required.

In the FX3GC series, use GX Developer Ver. 8.72A or later, and select “FX3G” as the model.

GX Developer does not support all functions of the FX3G/FX3GC series.

## 4. Program conversion method

### ● Connection method

For connecting the programming tool with the PLC, the following cables and interface are additionally required.

#### ■ Personal computer connection

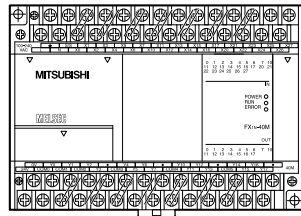

FX1N and FX1NC series PLCs  
(The diagram shows the FX1N PLC).

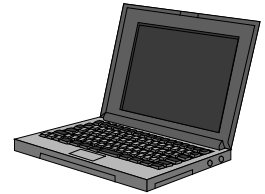
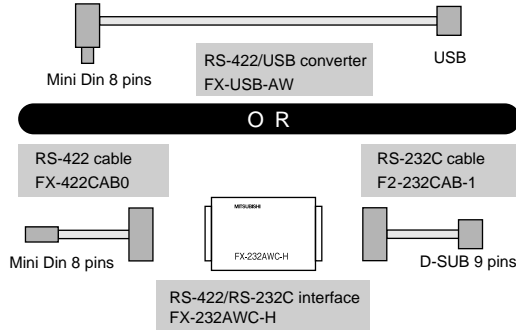

Personal computer  
• Programming software  
- GX Works2 (SW1DNC-GXW2)  
- GX Developer(SW□D5C-GPPW)

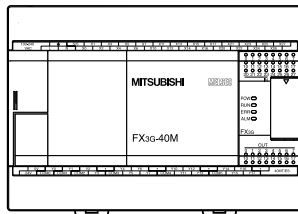

FX3G and FX3GC series PLCs  
(The diagram shows the FX3G PLC).

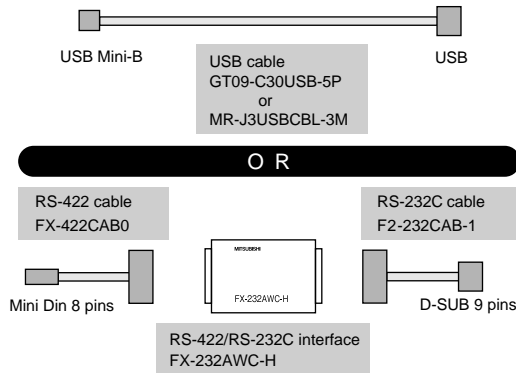

Personal computer  
• Programming software  
- GX Works2 (SW1DNC-GXW2)  
- GX Developer(SW□D5C-GPPW)

#### ■ Handy programming panel connection

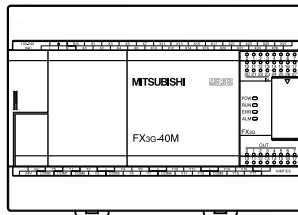

FX1N, FX1NC, FX3G and FX3GC series PLCs  
(The diagram shows the FX3G PLC).

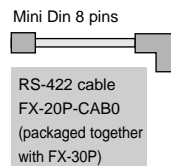

FX-30P

## 4. Program conversion method

### 4.2 Conversion of program by using GX Works2

This section explains the conversion procedure using the GX Works2 software application.  
(The conversion procedure is the same in GX Developer Ver. 8).

#### 4.2.1 Preparation for program conversion

Please prepare the following items before performing conversion of a program to FX3 series using GX Works2.

- FX PLC containing the source program, or saved program data.
- Personal computer with GX Works2 installed.
- Connection cable between PLC and personal computer (See Subsection 4.1.2).
- Related manuals (See Appendix B for related manuals).

#### 4.2.2 Reading of program

- Reading source program from PLC
- (1) Connect the FX PLC to the personal computer  
(See Subsection 4.1.2).
  - (2) Start GX Works2, and select “Online” → “Read from PLC...” from the menu.
  - (3) Select “FXCPU” for the PLC series selection.
  - (4) Set the connection destination based on the current method of connection.

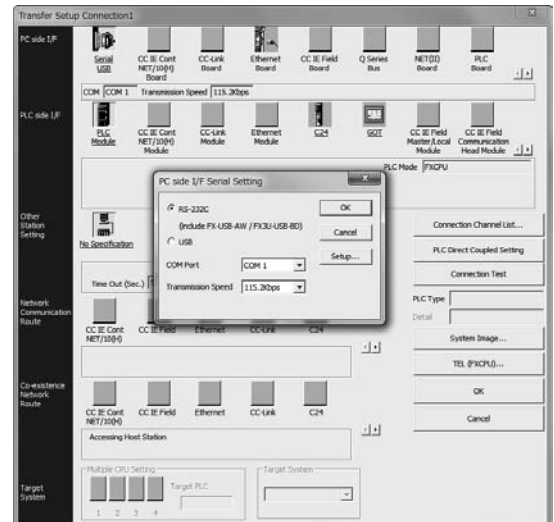
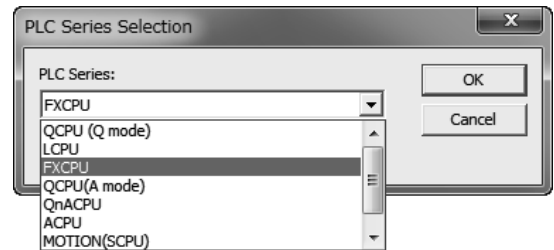

- (5) Click “Parameter + Program”, and designate the data to be read out.  
Click “Execute”, and execute reading.

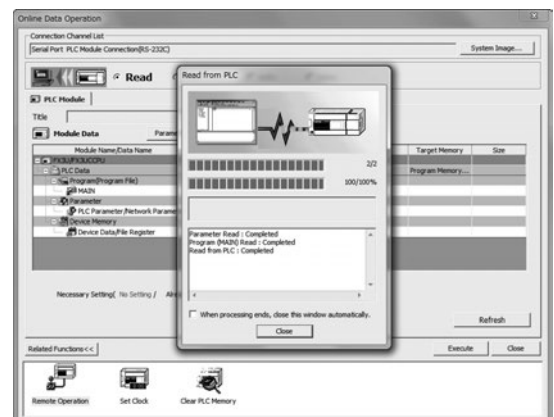

- (6) Once PLC reading is complete, confirm the reading result of the sequence program on the program display screen.

## 4. Program conversion method

---

- Reading source program from saved project data
  - (1) Locate the saved data for the source program.
  - (2) Start GX Works2.
  - (3) Select and open out the source project.
    - When the project is saved as a GX Works2 type file  
Select “Project” → “Open project” from the menu, and select the conversion source file.
    - When the project is saved as a GX Developer type file  
Select “Project” → “Open other data” → “Open other project” from the menu, and select the conversion source file.
  - (4) Confirm the sequence program on the program display screen.

## 4. Program conversion method

### 4.2.3 Model change to FX3 series (change of PLC type)

Change the PLC type of the target program to FX3 series.

- (1) Select “Project” → “Change PLC type...” from the menu.

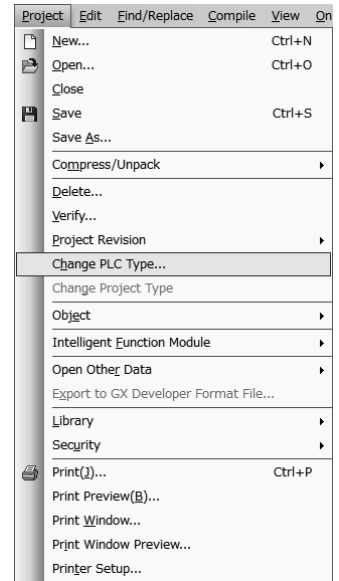

- (2) In the “Change PLC type...” dialog box, select the FX3 series main unit type to be used from the “PLC type” drop down list and click “OK”.

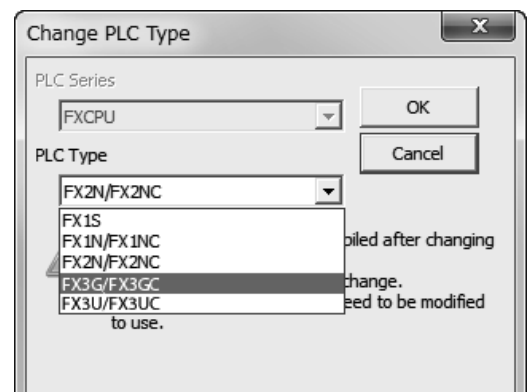

- (3) A dialog box appears, listing cautions and asking to confirm the PLC type change. After reading the contents select “OK”.

When the type change has been completed, a dialog box confirming that the operation was successful appears.

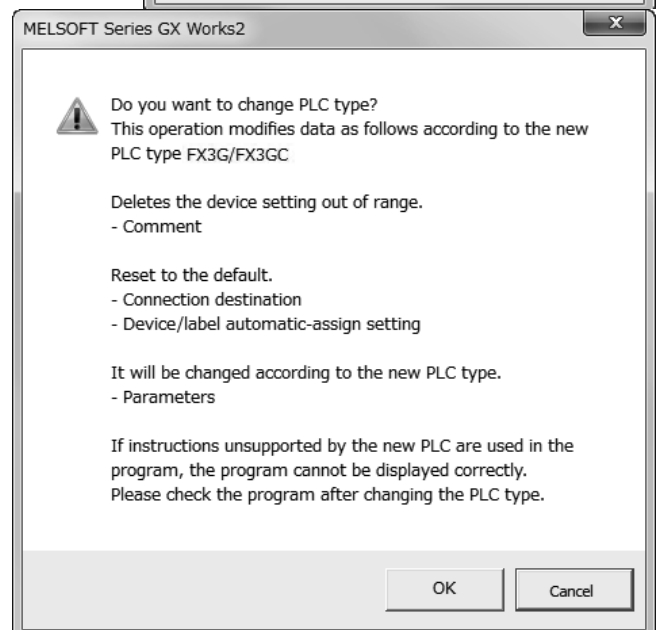

### 4.3 Correction of program and checking of operation

---

#### 4.3.1 Checking and correction of program

- After changing the PLC type to FX3 series, check the program by referring to the program conversion cautions of each PLC, and check the program contents and correct affected functions.
- To check the sequence program, from the GX Works2 menu, select items to check in “Tool” → “Check program...” or “Check parameter...”, and execute.
- Use of simulation function  
By using the simulation function of GX Works2, the operation of the program can be checked on the personal computer before downloading it to the PLC.  
From the GX Works2 menu, select “Debug” → “Start/Stop Simulation”. GX Simulator2 starts, and debugging is possible by examining the operation of the simulated PLC.

---

#### 4.3.2 Checking operation

- After completing changing the program to FX3 series, use the replacement hardware to run the program and then check and tune functions and operation timing of applicable equipment.  
When checking operation, pay attention to the differences in functions mentioned in this document, and make sure operation conforms with the designed specification.

## Appendix A. Models affected by production termination

---

In addition to the MELSEC-F series PLCs mentioned in this document, production of the following models has been terminated prior to the end of October 2014.

Discontinued model	Discontinuation date	Repair service period
F1 series	September 30, 2000	September 30, 2007
F1J series	September 30, 2000	September 30, 2007
F2 series	September 30, 1995	September 30, 2002
FX0 series	June 30, 2002	June 30, 2009
FX0S series	January 31, 2006	January 31, 2013
FX0N series	January 31, 2006	January 31, 2013
FX1 series	June 30, 2002	June 30, 2009
FX2 series	June 30, 2002	June 30, 2009
FX2C series	June 30, 2002	June 30, 2009
FX2N series	September 30, 2012	September 30, 2019
FX2NC series	September 30, 2012	September 30, 2019



### Appendix B. Related manuals

Before use, please read this document together with the user's manual of the PLC main unit, and the manual of the program conversion tool used. Read these manuals carefully to obtain a full understanding of the product specifications and operations, prior to starting operation.

The necessary manuals are available from your local representative.

#### ■ FX1N/FX1NC series related

Reference document		Contents
Type	Manual name (manual number)	
Main unit	FX1N series hardware manual (manual number: JY992D89301)	Includes input and output specification, wiring, mounting instructions, and explanation of basic commands, application commands and various devices in FX1N series.
	FX1N-BAT user's manual (manual number: JY997D10201)	Includes names of parts, overall dimensions, mounting instructions, and explanation of maintenance in FX1N-BAT type battery units.
Analog input and output	FX1N-2AD-BD user's manual (manual number: JY992D96201)	Includes names of parts, overall dimensions, mounting instructions, and specifications in FX1N-2AD-BD type analog input boards.
	FX1N-1DA-BD user's manual (manual number: JY992D96401)	Includes names of parts, overall dimensions, mounting instructions, and specifications in FX1N-1DA-BD type analog output boards.
	FX1N-8AV-BD manual (manual number: JY992D84601)	Includes names of parts, overall dimensions, mounting instructions, and specifications in FX1N-8AV-BD type analog volumes.
	FX0N-3A user's guide (manual number: JY992D49001)	Includes names of parts, overall dimensions, mounting instructions, and specifications in FX0N-3A type analog input and output blocks.
Communication	FX1N-232-BD user's guide (manual number: JY992D84401)	Includes names of parts, overall dimensions, mounting instructions, and specifications in FX1N-232-BD type RS-232C communication boards.
	FX1N-422-BD user's guide (manual number: JY992D84101)	Includes names of parts, overall dimensions, mounting instructions, and specifications in FX1N-422-BD type RS-422 communication boards.
	FX1N-485-BD user's guide (manual number: JY992D84201)	Includes names of parts, overall dimensions, mounting instructions, and specifications in FX1N-485-BD type RS-485 communication boards.
	FX2NC-232ADP installation manual (manual number: JY997D01101)	Includes names of parts, overall dimensions, mounting instructions, and specifications in FX2NC-232ADP type RS-232C communication adapters.
	FX2NC-485ADP installation manual (manual number: JY997D01201)	Includes names of parts, overall dimensions, mounting instructions, and specifications in FX2NC-485ADP type RS-485 communication adapters.
Programming	The FX series of programmable controller programming manual II (FX1S, FX1N, FX2N and FX2NC) (manual number: JY992D88101)	Includes sequence program instructions such as basic commands, step ladder commands, application commands, and various devices in FX1S, FX1N, FX2N, and FX2NC series .

## Appendix B. Related manuals

### ■ FX3G series related

Reference document		Contents
Type	Manual name (manual number)	
Main unit	FX3G series user's manual [hardware edition] (manual number: JY997D31301)	Includes FX3G series input and output specifications and hardware instructions such as wiring, mounting instructions.
	FX2N-CNV-BC user's guide (manual number: JY992D66601)	Includes system configuration and connection procedure of FX2N-CNV-BC type connector conversion adapters.
Extension	FX3G-4EX-BD user's manual (manual number: JY997D51301)	Includes names of parts, overall dimensions, mounting instructions, and specifications of FX3G-4EX-BD type input expansion boards.
	FX3G-2EYT-BD user's manual (manual number: JY997D51401)	Includes names of parts, overall dimensions, mounting instructions, and specifications of FX3G-2EYT-BD type output expansion boards.
Analog input and output	FX3G, FX3U, FX3GC and FX3UC series user's manual [analog control edition] (manual number: JY997D16701)	Includes FX3G, FX3U, FX3GC and FX3UC series analog control.
	FX3G-2AD-BD installation manual (manual number: JY997D33501)	Includes names of parts, overall dimensions, mounting instructions, and specifications in FX3G-2AD-BD type analog input boards.
	FX3G-1DA-BD installation manual (manual number: JY997D33601)	Includes names of parts, overall dimensions, mounting instructions, and specifications in FX3G-1DA-BD type analog output boards.
	FX3G-8AV-BD installation manual (manual number: JY997D33701)	Includes names of parts, overall dimensions, mounting instructions, and specifications in FX3G-8AV-BD type analog volumes.
	FX3U-3A-ADP user's manual (manual number: JY997D35601)	Includes names of parts, overall dimensions, and specifications in FX3U-3A-ADP type analog input and output adapters.
	FX3U-4AD-ADP user's manual (manual number: JY997D13901)	Includes names of parts, overall dimensions, and specifications in FX3U-4AD-ADP type analog input adapters.
	FX3U-4AD installation manual (manual number: JY997D20701)	Includes names of parts, overall dimensions, mounting instructions, and specifications of FX3U-4AD analog input special function blocks.
	FX3U-4DA-ADP user's manual (manual number: JY997D14001)	Includes names of parts, overall dimensions, mounting instructions, and specifications in FX3U-4DA-ADP type analog output adapters.
	FX3U-4DA installation manual (manual number: JY997D20801)	Includes names of parts, overall dimensions, mounting instructions, and specifications of FX3U-4DA analog output special function blocks.
Analog input (temperature control)	FX3U-4AD-PT-ADP user's manual (manual number: JY997D14701)	Includes names of parts, overall dimensions, mounting instructions, and specifications in FX3U-4AD-PT-ADP type temperature sensor input adapters.
	FX3U-4AD-PTW-ADP user's manual (manual number: JY997D29101)	Includes names of parts, overall dimensions, mounting instructions, and specifications in FX3U-4AD-PTW-ADP type temperature sensor input adapters.
	FX3U-4AD-PNK-ADP user's manual (manual number: JY997D29201)	Includes names of parts, overall dimensions, mounting instructions, and specifications of FX3U-4AD-PNK-ADP type temperature sensor input adapters.
	FX3U-4AD-TC-ADP user's manual (manual number: JY997D14801)	Includes names of parts, overall dimensions, and specifications in FX3U-4AD-TC-ADP type temperature sensor input adapters.
	FX3U-4LC user's manual (manual number: JY997D39101)	Includes names of parts, overall dimensions, mounting instructions, and specifications of FX3U-4LC temperature special function blocks.

## Appendix B. Related manuals

Reference document		Contents
Type	Manual name (manual number)	
Communication	FX series user's manual [data communication control edition] (manual number: JY997D16901)	Includes configurations of simplified inter-PC link/parallel link/computer link/inverter communication/no-procedure communication/programming communication, function explanation, and program examples.
	FX3G-232-BD installation manual (manual number: JY997D32001)	Includes names of parts, overall dimensions, mounting instructions, and specifications in FX3G-232-BD type RS-232C communication boards.
	FX3G-422-BD installation manual (manual number: JY997D32101)	Includes names of parts, overall dimensions, mounting instructions, and specifications in FX3G-422-BD type RS-422 communication boards.
	FX3G-485-BD installation manual (manual number: JY997D32201)	Includes names of parts, overall dimensions, mounting instructions, and specifications in FX3G-485-BD type RS-485 communication boards.
	FX3G-485-BD-RJ user's manual (manual number: JY997D51501)	Includes names of parts, overall dimensions, mounting instructions, and specifications of FX3G-485-BD-RJ type RS-485 communication board.
	FX3U-232ADP-MB installation manual (manual number: JY997D26401)	Includes names of parts, overall dimensions, mounting instructions, and specifications of FX3U-232ADP-MB type RS-232C(MODBUS®) communication adapters.
	FX3U-485ADP-MB installation manual (manual number: JY997D26301)	Includes names of parts, overall dimensions, mounting instructions, and specifications of FX3U-485ADP-MB type RS-485(MODBUS) communication adapters.
Network	FX2N-64CL-M user's manual [detailed volume] (manual number: JY997D08501)	Includes names of parts, overall dimensions, and specifications in FX2N-64CL-M type CC-Link/LT master blocks.
	FX2N-16CCL-M user's manual (manual number: JY992D93101)	Includes names of parts, overall dimensions, and specifications in FX2N-16CCL-M type CC-Link master blocks.
	FX2N-32CCL user's manual (manual number: JY992D71801)	Includes names of parts, overall dimensions, and specifications in FX2N-32CCL type CC-Link slave blocks.
	FX3U-16CCL-M user's manual (manual number: JY997D43601)	Includes names of parts, overall dimensions, and specifications in FX3U-16CCL-M type CC-Link master blocks.
	FX3U-64CCL user's manual (manual number: JY997D30301)	Includes names of parts, overall dimensions, and specifications in FX3U-64CCL type CC-Link V2 interface blocks.
	FX3U-ENET-ADP user's manual (manual number: JY997D45801)	Includes names of parts, overall dimensions, and specifications in FX3U-ENET-ADP type Ethernet communication adapters.
	FX3U-ENET user's manual (manual number: JY997D18101)	Includes names of parts, overall dimensions, mounting instructions, and specifications of FX3U-ENET type Ethernet communication special function blocks.
	FX3U-32DP user's manual (manual number: JY997D25201)	Includes names of parts, overall dimensions, mounting instructions, and specifications of FX3U-32DP type PROFIBUS-DP interface block communication special function blocks.
	FX3U-CAN user's manual (manual number: JY997D43301)	Includes names of parts, overall dimensions, mounting instructions, and specifications of FX3U-ENET type CANopen® interface block communication special function blocks.
	FX3U-J1939 user's manual (manual number: JY997D43101)	Includes names of parts, overall dimensions, mounting instructions, and specifications of FX3U-J1939 type J1939 system interface block communication special function blocks.

**1** Introduction

**2** Replacement of FX1N series

**3** Replacement of FX1N series

**4** Program changeover method

**A** Models affected by production termination

**B** Related manuals

**C** Frequently asked questions

## Appendix B. Related manuals

---

Reference document		Contents
Type	Manual name (manual number)	
Programming	FX3G, FX3U, FX3GC, FX3UC and FX3S series programming manual [basic & applied Instruction Edition] (manual number: JY997D16601)	Includes sequence program instructions such as basic commands, step ladder commands, application commands, and description of various devices in FX3G, FX3U, FX3GC, and FX3UC series.
	FX-30P operation manual (manual number: JY997D34401)	Includes sequence program instructions such as list editing basic commands, step ladder commands, and application commands.

## Appendix B. Related manuals

### ■ FX3GC series related

Reference document		Contents
Type	Manual name (manual number)	
Main unit	FX3GC series user's manual [hardware edition] (manual number: JY997D45401)	Includes hardware instructions such as input and output specifications, wiring, and mounting instructions in FX3GC series.
	FX2N-CNV-BC user's guide (manual number: JY992D66601)	Includes system configuration and connection procedure in FX2N-CNV-BC type connector conversion adapter.
Analog input and output	FX3G, FX3U, FX3GC, and FX3UC series user's manual [analog control edition] (manual number: JY997D16701)	Includes FX3G, FX3U, FX3GC, and FX3UC series analog control.
	FX3U-3A-ADP user's manual (manual number: JY997D35601)	Includes names of parts, overall dimensions, and specifications in FX3U-3A-ADP type analog input and output adapters.
	FX3U-4AD-ADP user's manual (manual number: JY997D13901)	Includes names of parts, overall dimensions, and specifications in FX3U-4AD-ADP type analog input adapters.
	FX3U-4AD installation manual (manual number: JY997D20701)	Includes names of parts, overall dimensions, mounting instructions, and specifications of FX3U-4AD analog input special function blocks.
	FX3U-4DA-ADP user's manual (manual number: JY997D14001)	Includes names of parts and overall dimensions in FX3U-4DA-ADP type analog output adapters.
	FX3U-4DA installation manual (manual number: JY997D20801)	Includes names of parts, overall dimensions, mounting instructions, and specifications of FX3U-4DA analog output special function blocks.
Analog input (temperature control)	FX3U-4AD-PT-ADP user's manual (manual number: JY997D14701)	Includes names of parts, overall dimensions, and specifications in FX3U-4AD-PT-ADP type temperature sensor input adapters.
	FX3U-4AD-PTW-ADP user's manual (manual number: JY997D29101)	Includes names of parts, overall dimensions, and specifications in FX3U-4AD-PTW-ADP type temperature sensor input adapters.
	FX3U-4AD-PNK-ADP user's manual (manual number: JY997D29201)	Includes names of parts, overall dimensions, mounting instructions, and specifications of FX3U-4AD-PNK-ADP type temperature sensor input adapters.
	FX3U-4AD-TC-ADP user's manual (manual number: JY997D14801)	Includes names of parts, overall dimensions, and specifications in FX3U-4AD-TC-ADP type temperature sensor input adapters.
	FX3U-4LC user's manual (manual number: JY997D39101)	Includes names of parts, overall dimensions, mounting instructions, and specifications of FX3U-4LC temperature special function blocks.
Positioning	FX3G, FX3U, FX3GC and FX3UC series user's manual [positioning control edition] (manual number: JY997D16801)	Includes FX3G, FX3U, FX3GC, and FX3UC series positioning control.
Communication	FX series user's manual [data communication edition] (manual number: JY997D16901)	Includes configurations of simplified inter-PC link/parallel link/computer link/inverter communication/no-procedure communication/programming communication, function explanation, and program examples.
	FX3U-232ADP-MB installation manual (manual number: JY997D26401)	Includes names of parts, overall dimensions, mounting instructions, and specifications of FX3U-232ADP-MB type RS-232C(MODBUS) communication adapters.
	FX3U-485ADP-MB installation manual (manual number: JY997D26301)	Includes names of parts, overall dimensions, mounting instructions, and specifications of FX3U-485ADP-MB type RS-485(MODBUS) communication adapters.

1 Introduction

2 Replacement of FX1N series

3 Replacement of FX1N series

4 Program changeover method

A Models affected by production termination

B Related manuals

C Frequently asked questions

## Appendix B. Related manuals

Reference document		Contents
Type	Manual name (manual number)	
Network	FX2N-64CL-M user's manual [detailed volume] (manual number: JY997D08501)	Includes names of parts, overall dimensions, and specifications in FX2N-64CL-M type CC-Link/LT master blocks.
	FX2N-16CCL-M user's manual (manual number: JY992D93101)	Includes names of parts, overall dimensions, and specifications in FX2N-16CCL-M type CC-Link master blocks.
	FX2N-32CCL user's manual (manual number: JY992D71801)	Includes names of parts, overall dimensions, and specifications in FX2N-32CCL type CC-Link slave blocks.
	FX3U-16CCL-M user's manual (manual number: JY997D43601)	Includes names of parts, overall dimensions, and specifications in FX3U-16CCL-M type CC-Link master blocks.
	FX3U-64CCL user's manual (manual number: JY997D30301)	Includes names of parts, overall dimensions, and specifications in FX3U-64CCL type CC-Link V2 interface blocks.
	FX3U-ENET-ADP user's manual (manual number: JY997D45801)	Includes names of parts, overall dimensions, and specifications in FX3U-ENET-ADP type Ethernet communication adapters.
	FX3U-ENET user's manual (manual number: JY997D18101)	Includes names of parts, overall dimensions, mounting instructions, and specifications of FX3U-ENET type Ethernet communication special function blocks.
	FX3U-32DP user's manual (manual number: JY997D25201)	Includes names of parts, overall dimensions, mounting instructions, and specifications of FX3U-32DP type PROFIBUS-DP interface block communication special function blocks.
	FX3U-CAN user's manual (manual number: JY997D43301)	Includes names of parts, overall dimensions, mounting instructions, and specifications of FX3U-ENET type CANopen® interface block communication special function blocks.
	FX3U-J1939 user's manual (manual number: JY997D43101)	Includes names of parts, overall dimensions, mounting instructions, and specifications of FX3U-J1939 type J1939 system interface block communication special function blocks.
Programming	FX3G, FX3U, FX3GC, FX3UC and FX3S series programming manual [basic & applied Instruction Edition] (manual number: JY997D16601)	Includes sequence program instructions such as basic commands, step ladder commands, application commands, and description of various devices in FX3G, FX3U, FX3GC, and FX3UC series.
	FX-30P operation manual (manual number: JY997D34401)	Includes sequence program instructions such as list editing basic commands, step ladder commands, and application commands in FX series.

# MEMO

**1** Introduction

**2** Replacement of FX1N series

**3** Replacement of FX1NC series

**4** Program changeover method

**A** Models affected by production termination

**B** Related manuals

**C** Frequently asked questions

\_\_\_\_\_

\_\_\_\_\_

\_\_\_\_\_

## Appendix C. Frequently asked questions

### ■ PLC

Q	A
Is there a difference in the maximum program capacity?	The FX1N(C) has 8,000 steps. FX3G(C) has 32,000 steps.
What is the maximum communication speed of the built-in programming port?	FX1N(C) operates at 19.2 kbps. FX3G(C) operates at 115.2 kbps.
Is the wiring of the FX1N directly usable in the FX3G?	Yes. However, an additional wiring that switches between the sink and source is required. (Use the terminal block for FX3G).
Are the connectors of the FX1NC detachable and usable in the FX3GC as replacements?	Yes. The wiring is also usable.
Can FX1N expansion boards be used by the FX3G?	No. FX3G expansion boards must be used.
Can FX1N optional battery units be used by the FX3G?	No. The optional battery FX3U-32BL compatible with the FX3G series must be used.

### ■ System

Q	A
Can FX0N extension units and blocks (FX0N-8EX, etc.) be used by the FX3G(C)?	No. Use extension blocks compatible with the FX3U.
Can FX1N special extension blocks be used by the FX3G?	The FX0N-3A, FX2N-16LNK-M and FX2N-32ASI-M cannot be used. Construct a new system using CC-Link and others.
The FX2N-CNV-BC and FX0N-65EC are being used in the current system. Can they be used by the FX3 series?	Yes. One extension cable can be connected to the system.
A FX1N(C) special adapter is being used for communications with the FX2NC. Can it be used by the FX3G(C) series?	No. Use a communication special adapter compatible with the FX3U.

### ■ Tool

Q	A
Can the FX-20P be used with the FX3G(C)?	Yes when “FX1N” is selected as the model. However, it is limited to the instructions and device range of the FX1N series.
Can FX-PCS/WIN be used with the FX3G(C)?	Yes when “FX1N” is selected as the model. However, corresponding commands and the ranges of devices are limited to the functional range of the FX1N.
Which versions of GX Developer support the FX3G(C)?	The FX3G series is supported in GX Developer Ver. 8.72A or later. When using the FX3GC series, select “FX3G” as the model. Earlier versions of the software may be used by selecting “FX1N”. However, it is limited to the instructions and device range of the FX1N series.



## Appendix C. Frequently asked questions

### ■ Connection of display units

Q	A
Can the FX-DU series of display units be connected directly to the FX3G(C)?	Yes. (Screen program modification is required when the sequence program is changed). However, corresponding commands and the ranges of devices are limited to the functional range of the FX1N.
Can the F940GOT series be connected directly to the FX3G(C)?	Yes. (Screen program modification is required when the sequence program is changed). However, corresponding commands and the ranges of devices are limited to the functional range of the FX1N.



# Revision history

---

Date compiled	Sub-number	Contents
Oct. 2014	A	First edition



**FX CPU**

**FX(FX1N,FX1NC)→FX3 series Replacement Guidance**

**mitsubishi**  
**MITSUBISHI ELECTRIC CORPORATION**

HEAD OFFICE : TOKYO BUILDING, 2-7-3 MARUNOUCHI, CHIYODA-KU, TOKYO 100-8310, JAPAN  
HIMEJI WORKS : 840, CHIYODA CHO, HIMEJI, JAPAN

---